

36
38
40

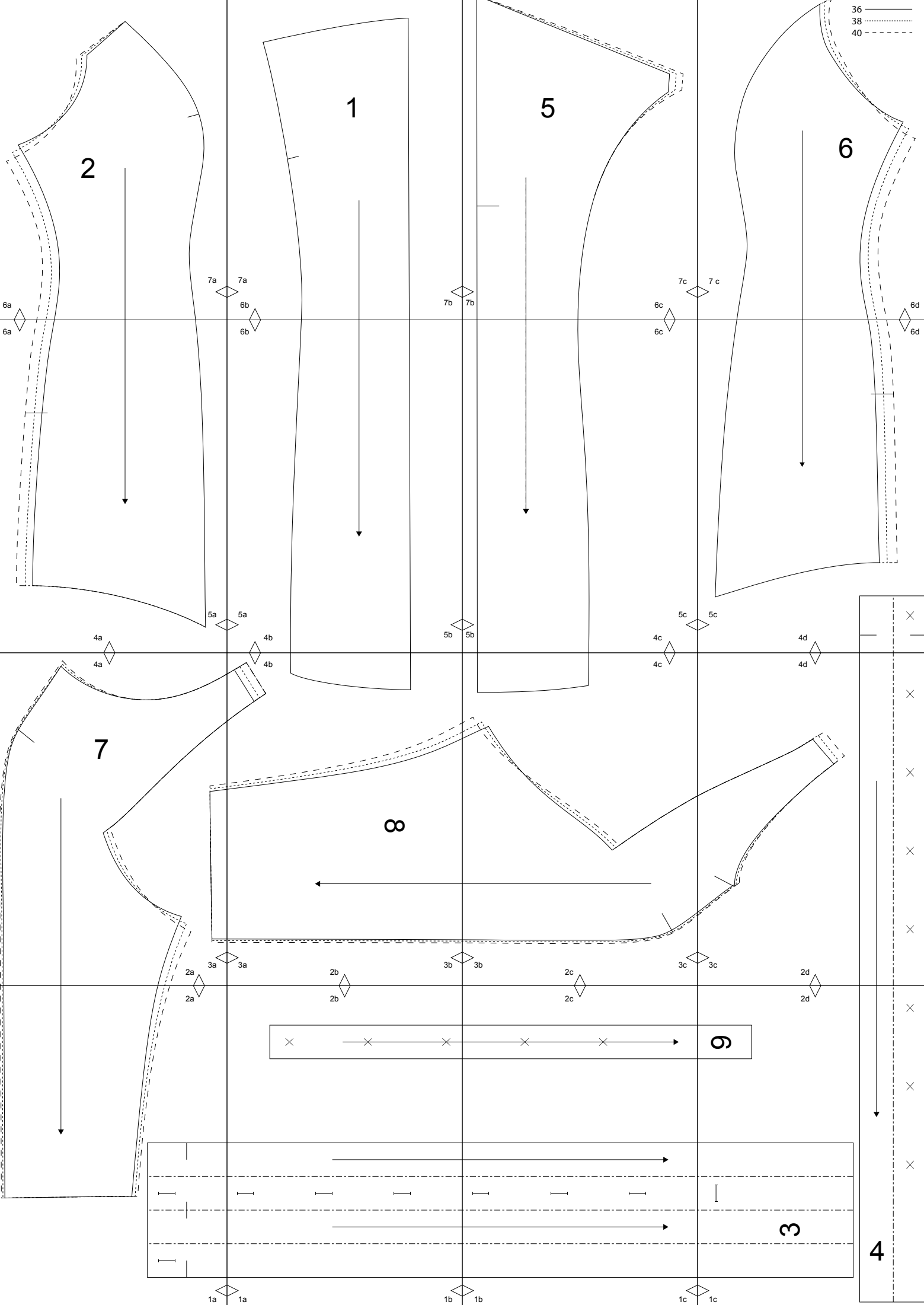

2

1

5

6

7

8

9

3

4

7a 7a

7b 7b

7c 7c

6a 6a

6b 6b

6c 6c

6d 6d

4a 4a

4b 4b

5b 5b

4c 4c

5c 5c

4d 4d

2a 2a

2b 2b

2c 2c

2d 2d

3a 3a

3b 3b

3c 3c

1a 1a

1b 1b

1c 1c

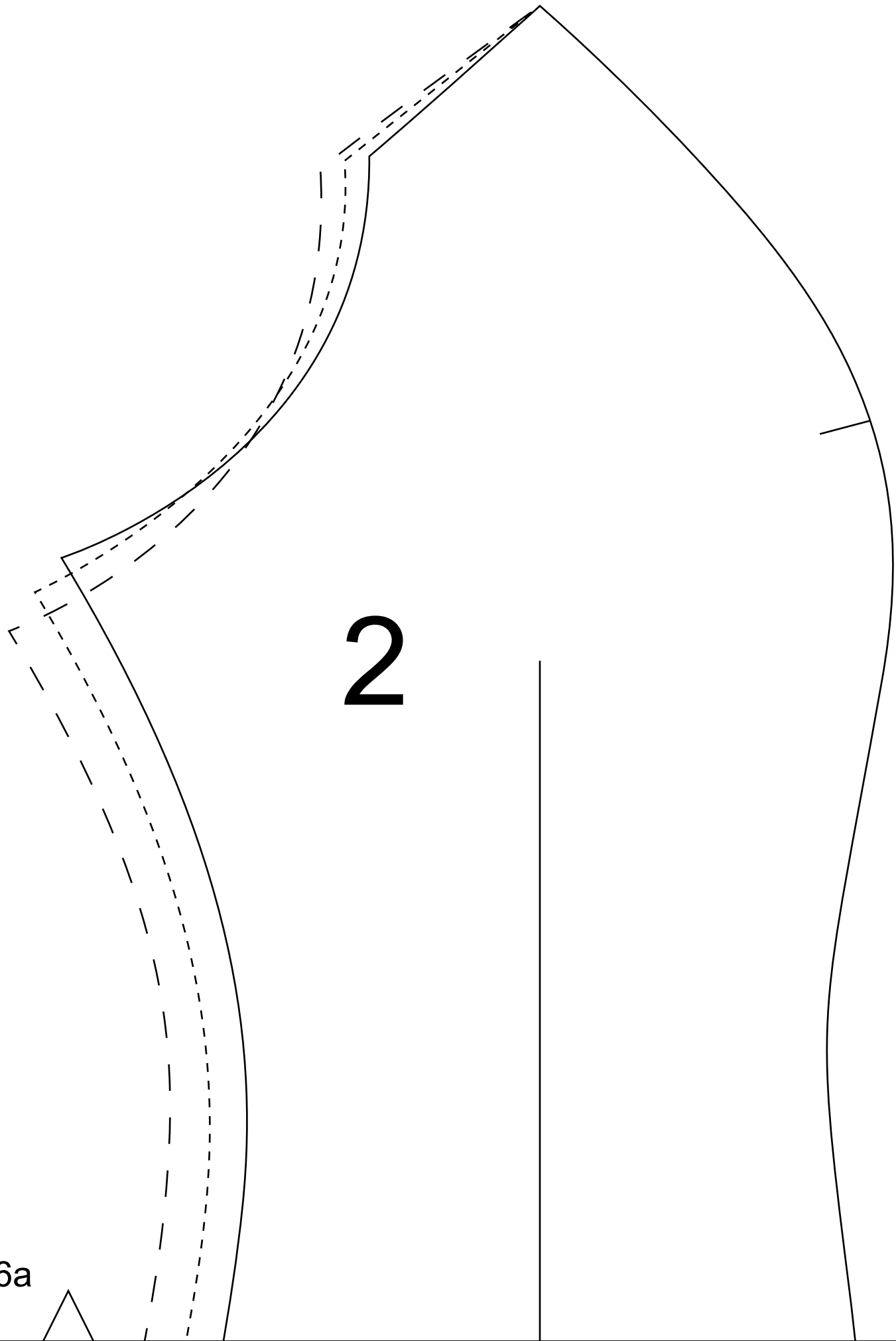

2

6a

7a

1

7a

6b

7b

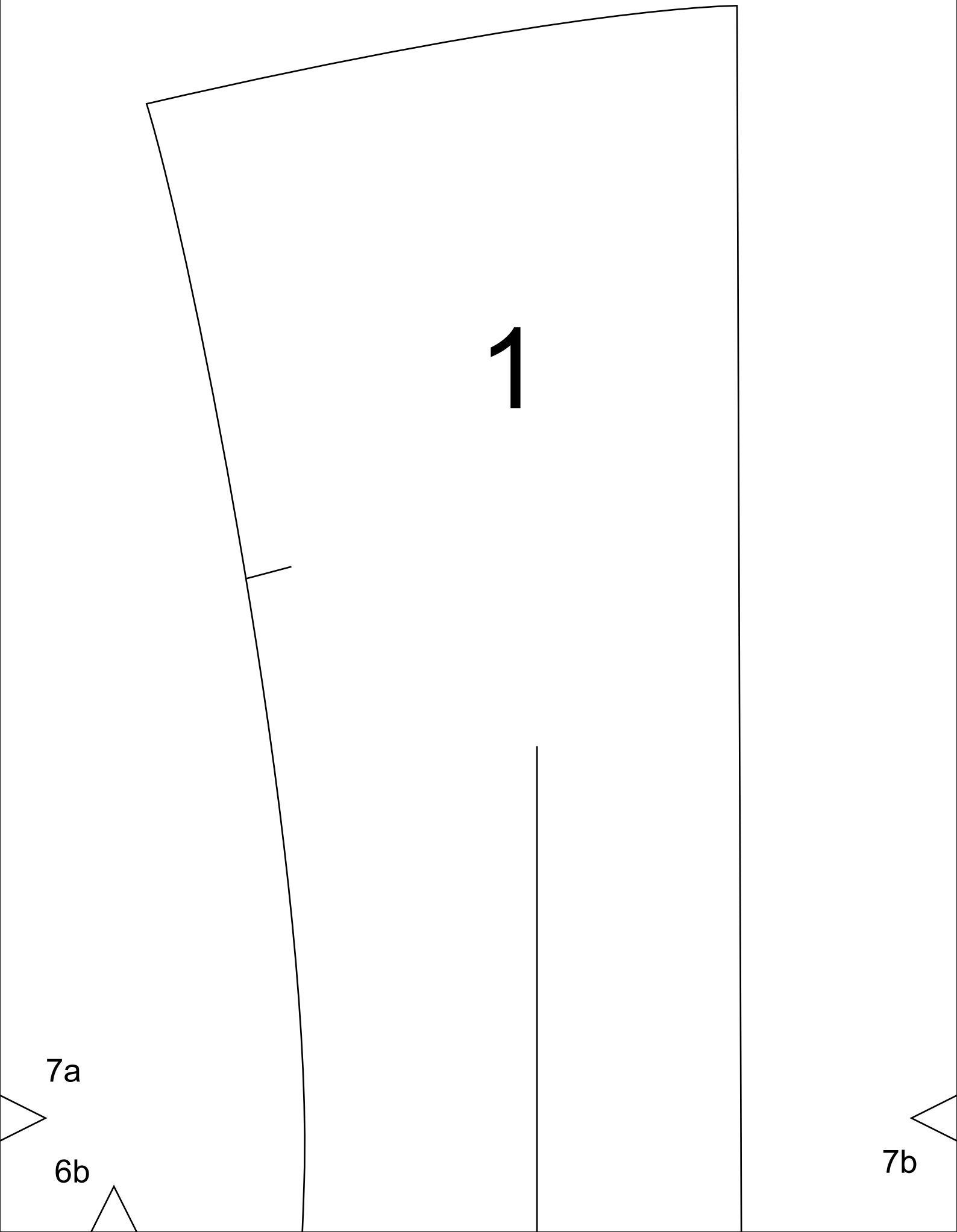

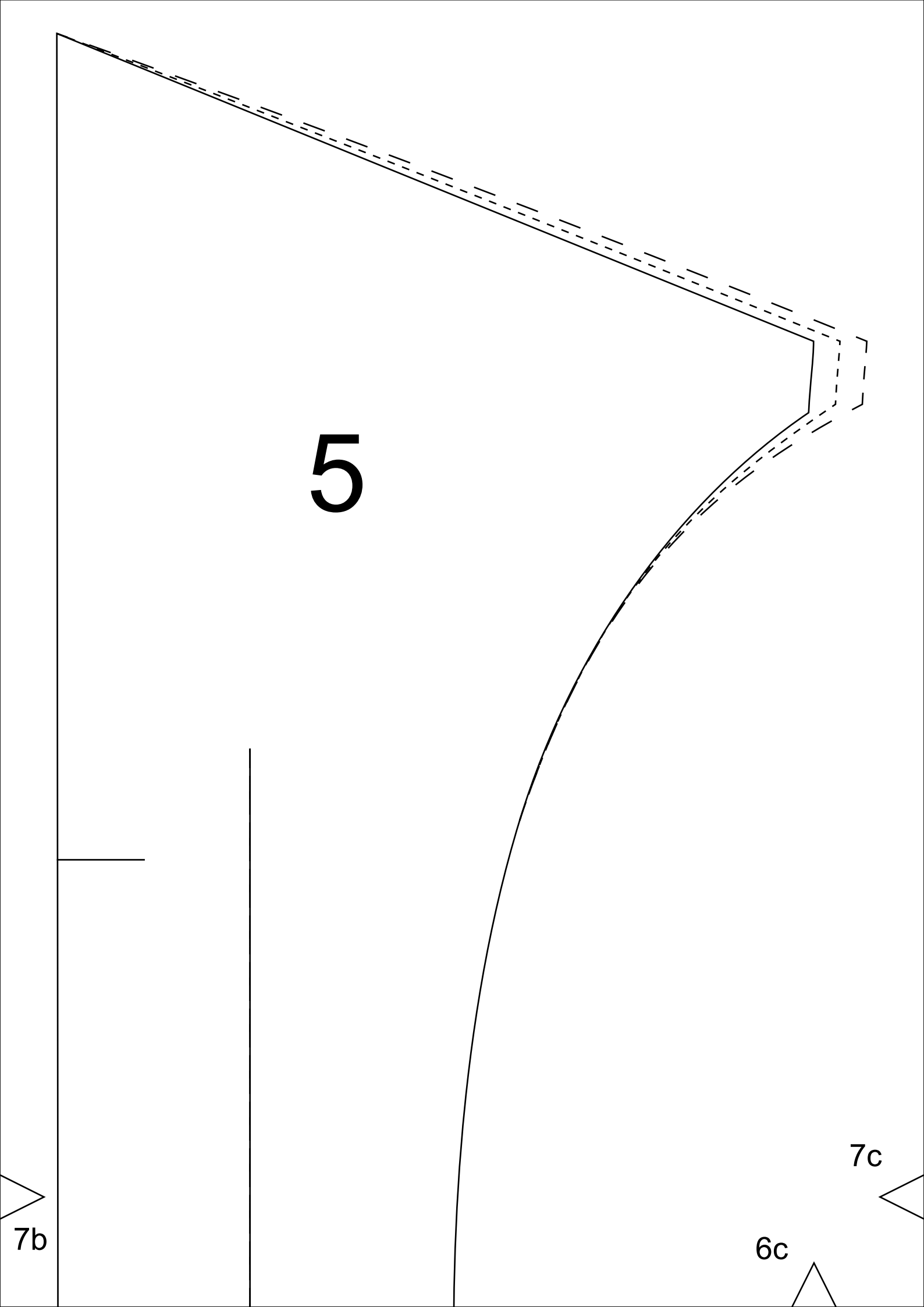

5

7b

6c

7c

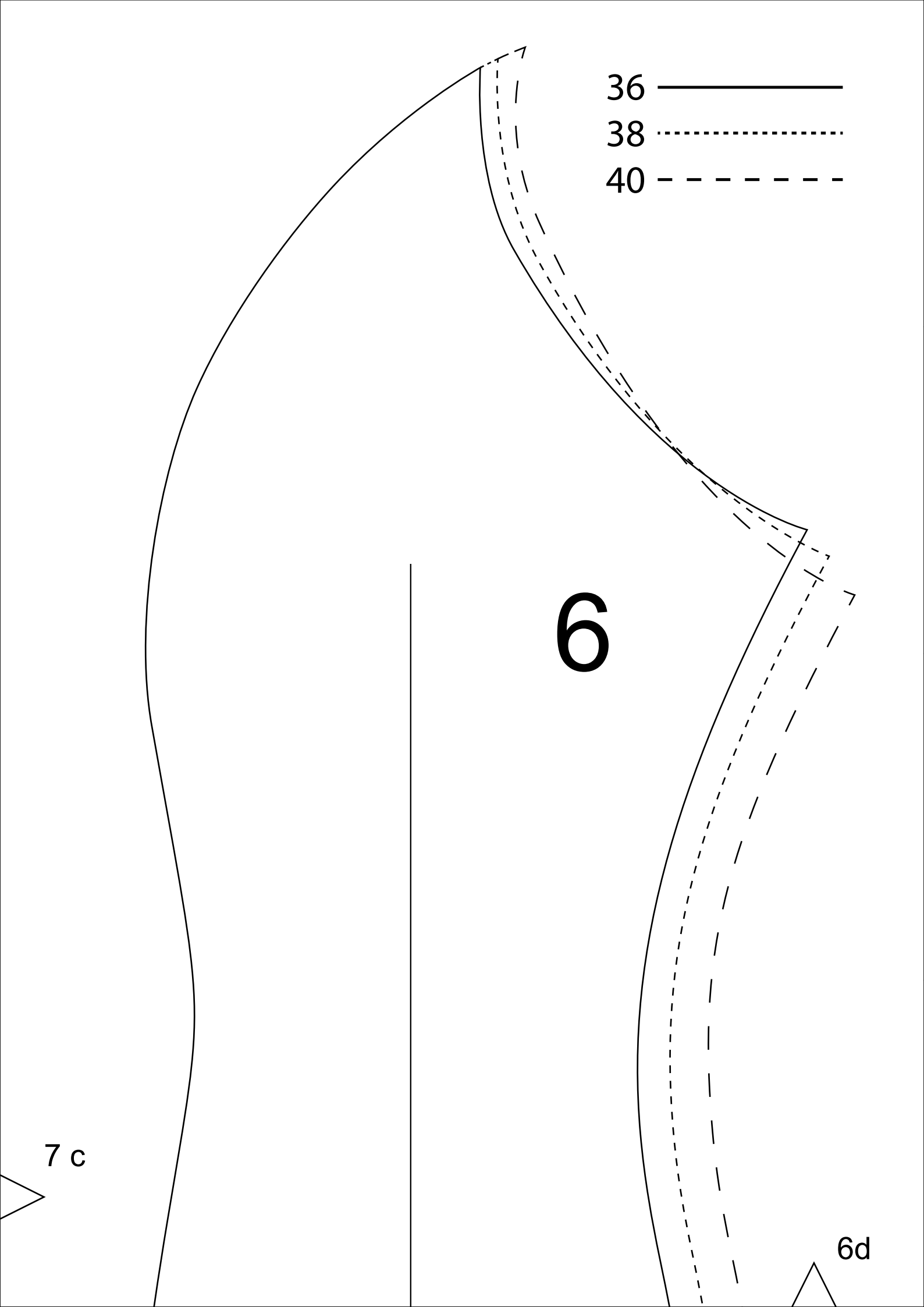

- 36 ———
- 38 (dotted)
- 40 - - - - (dashed)

6

7 c

6d

6a

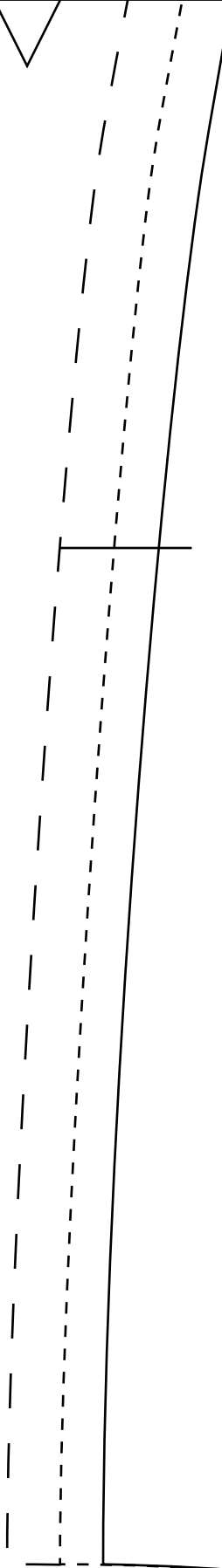

5a

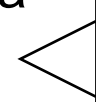

4a



6b

5a

4b

5b



6c



5c

4c

5b

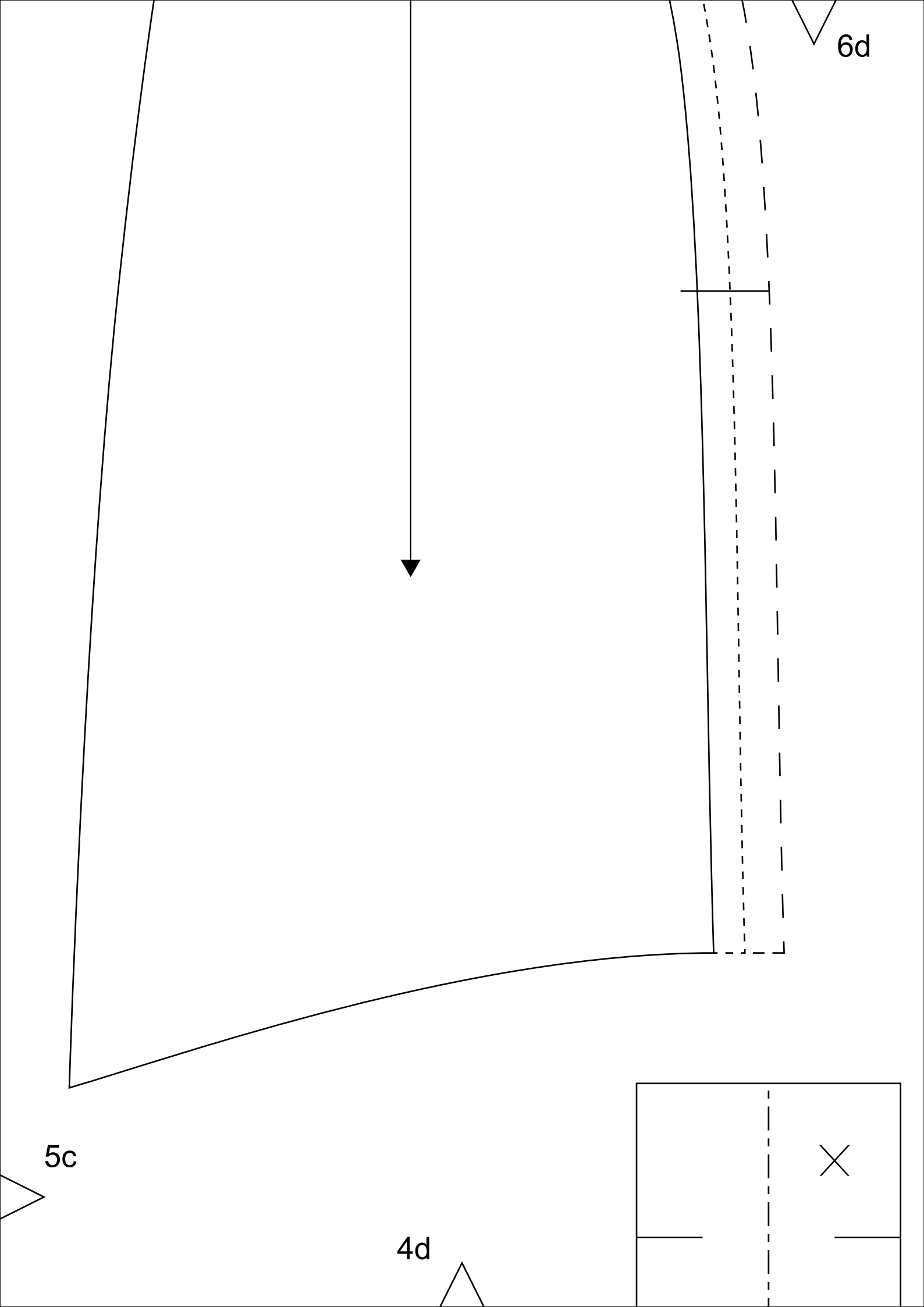

4a

7

3a

2a

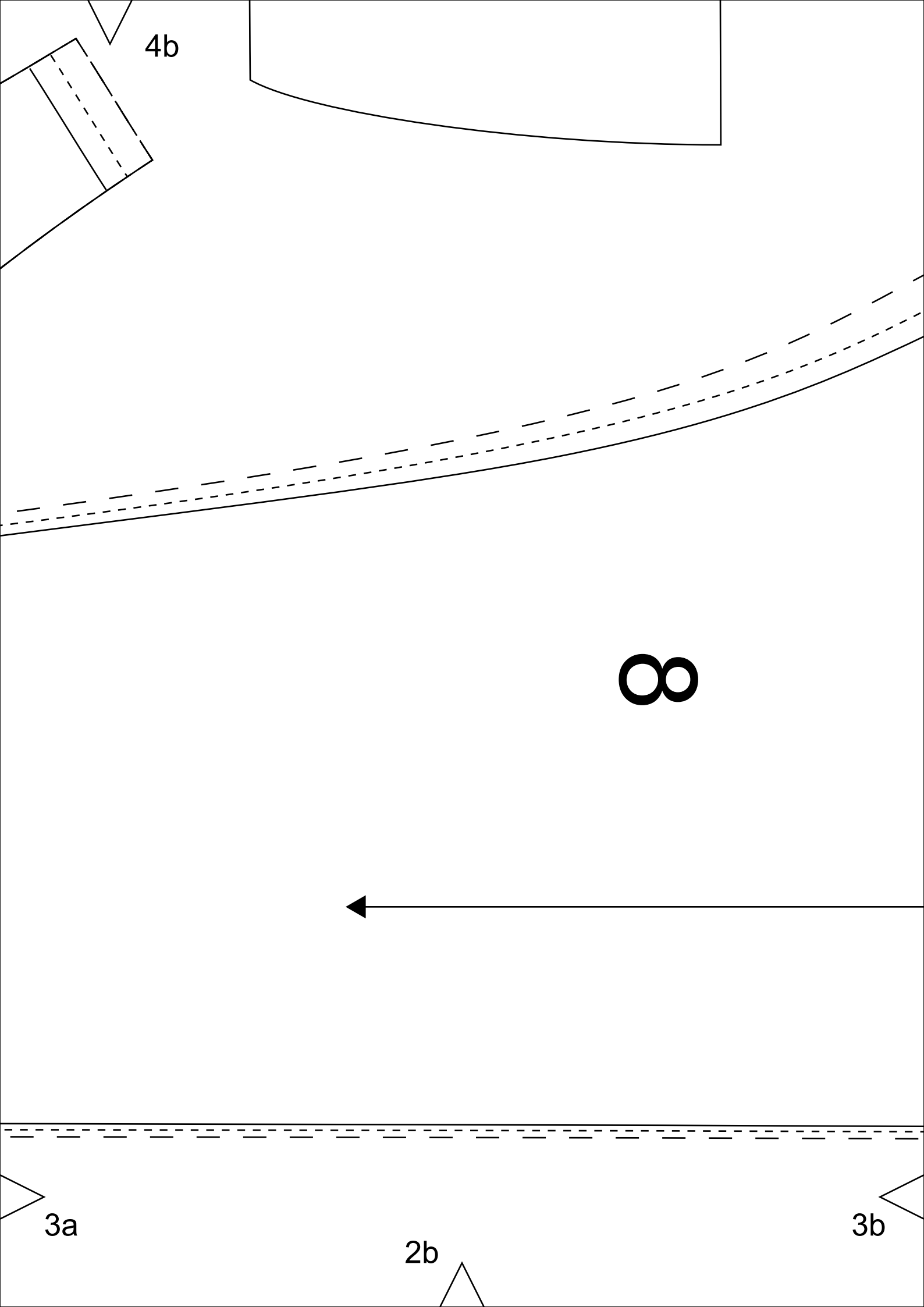

4b

∞



3a

2b

3b

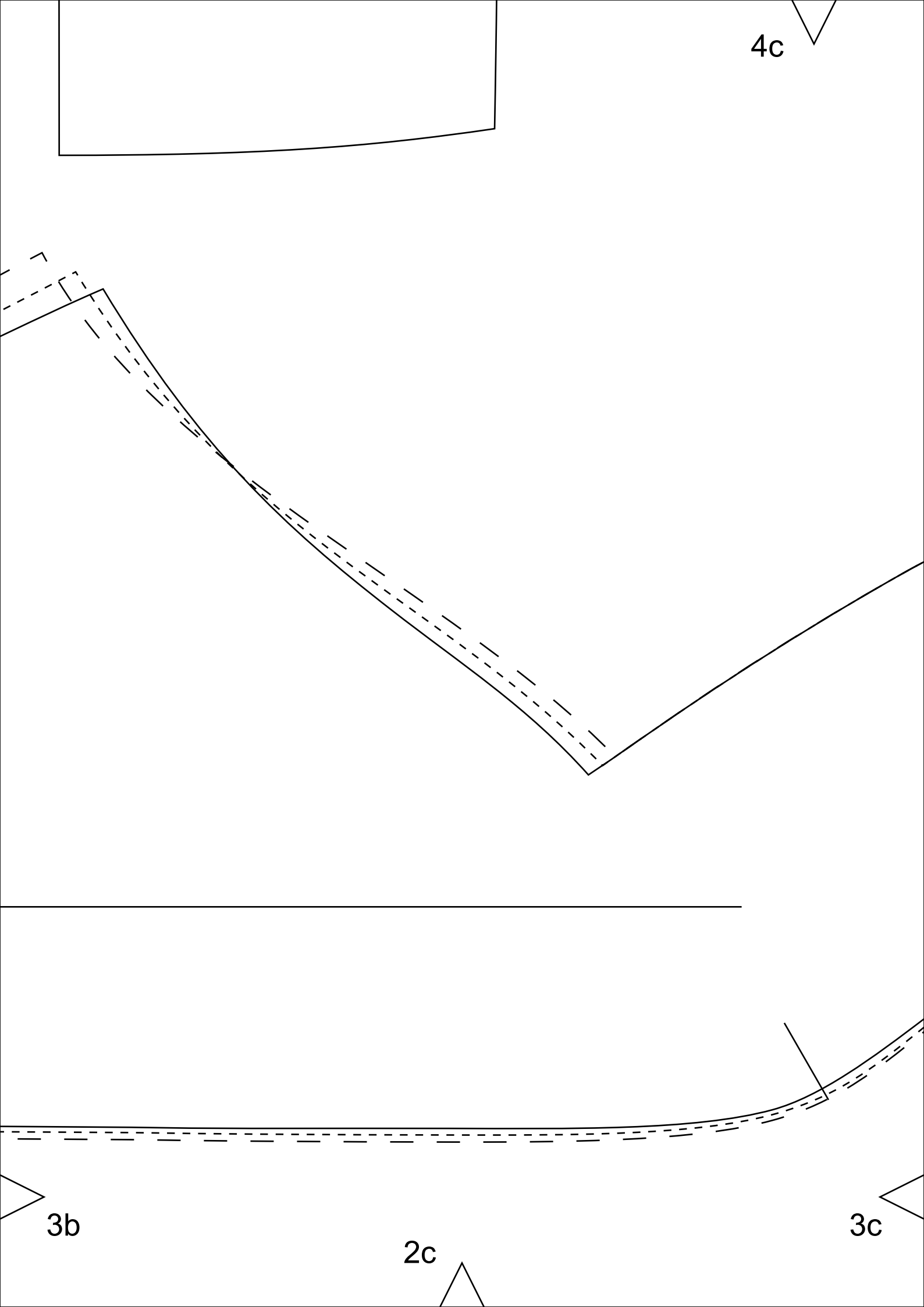

4c

3b

2c

3c

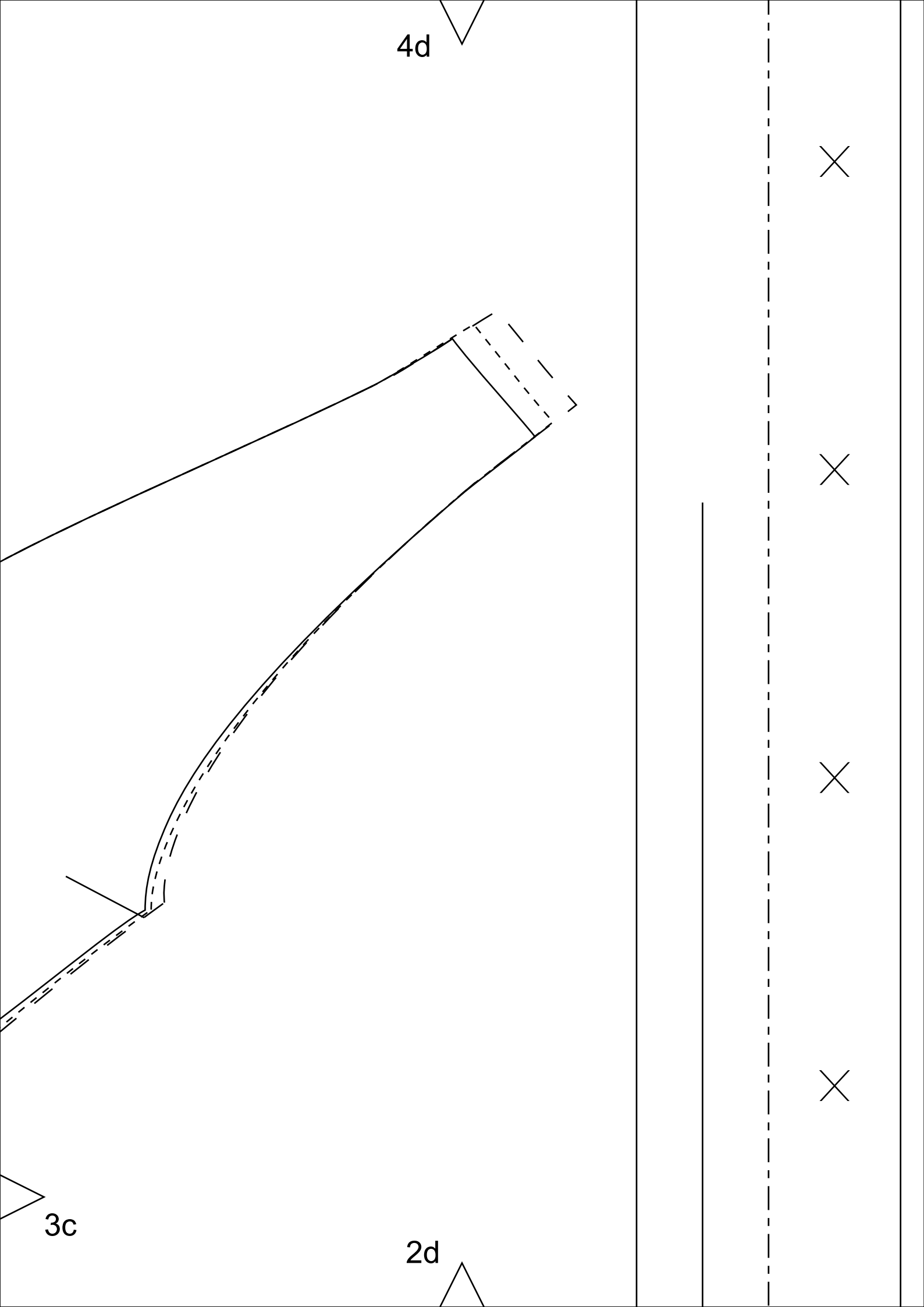

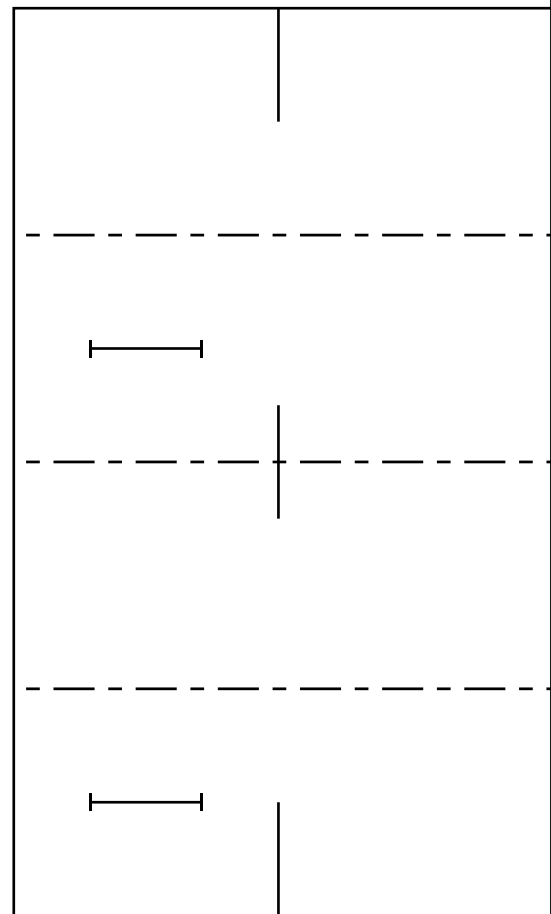
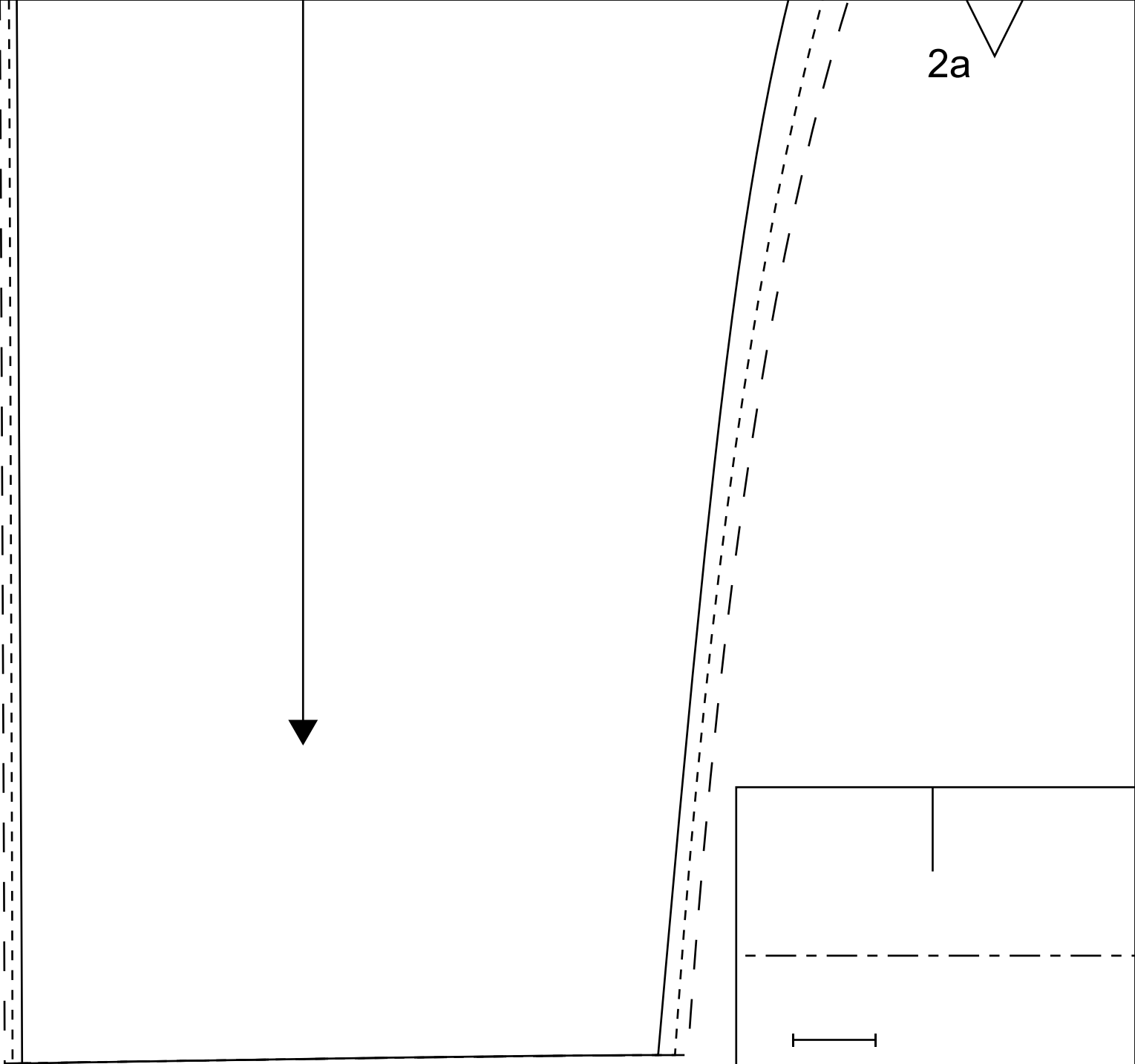

2b

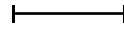
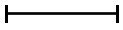
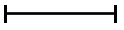
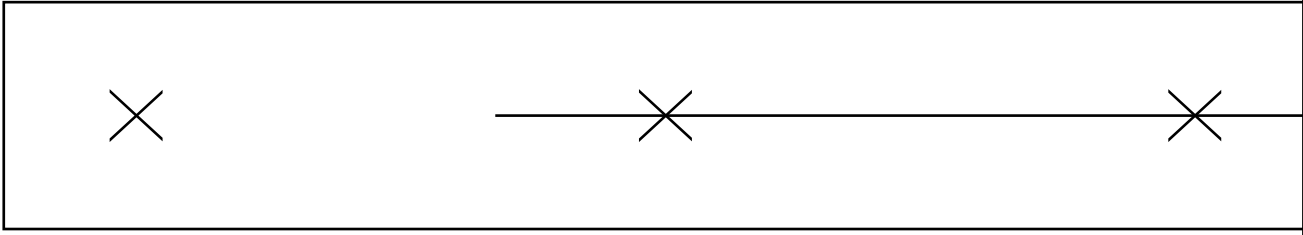

1a

1b

2c

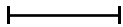

1b

1c

2d

9

I

3

1c

4

X

X

X