

36 ———
38 - - - - -
40 ·····

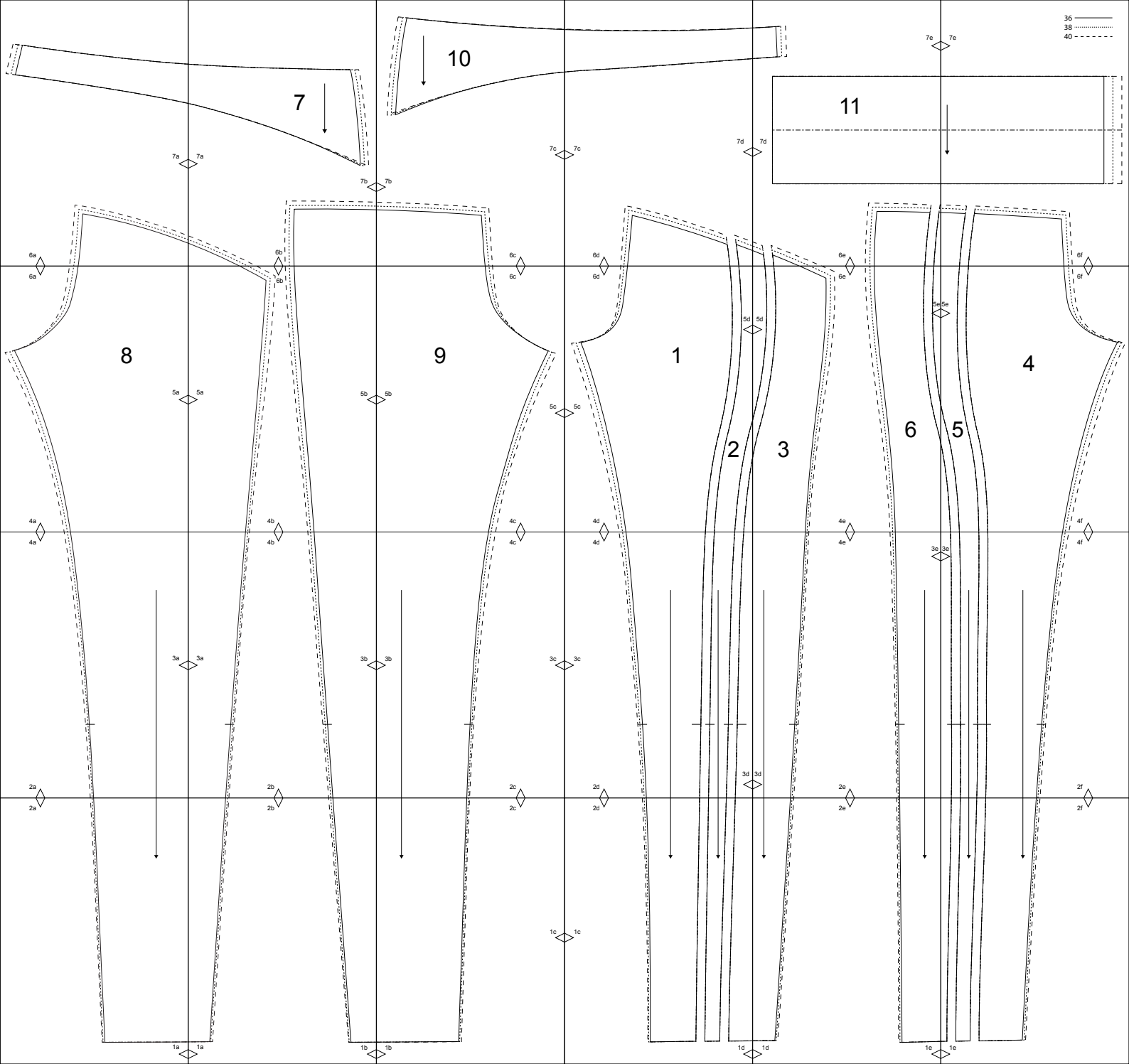

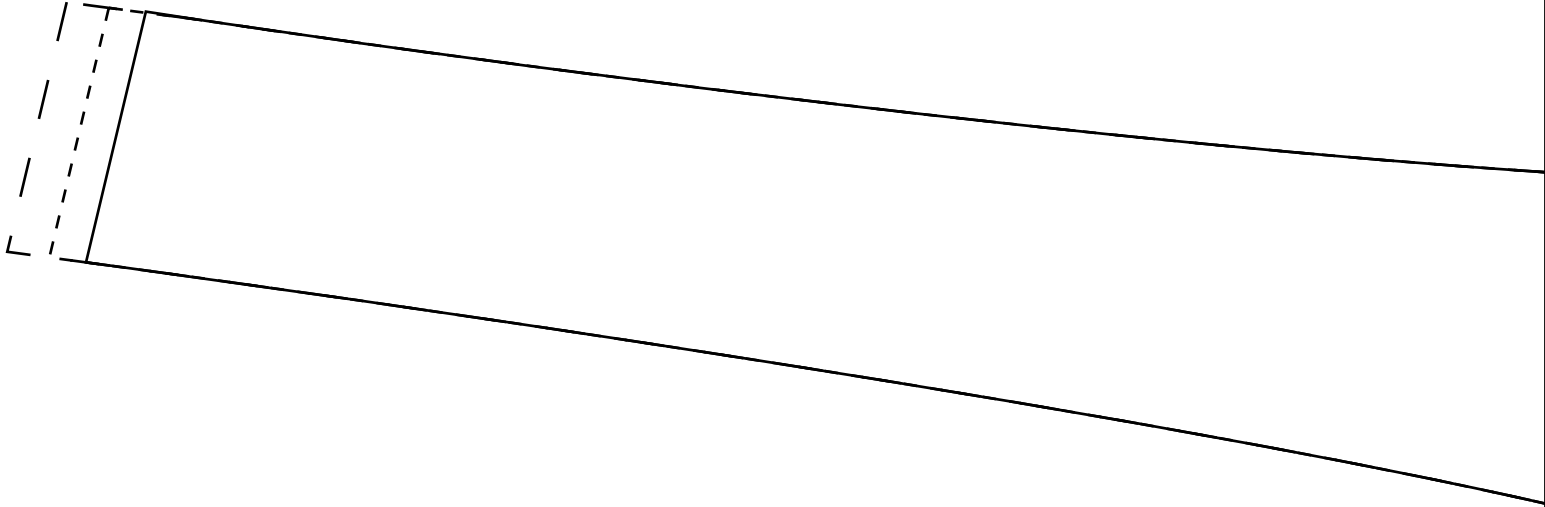

7a

6a

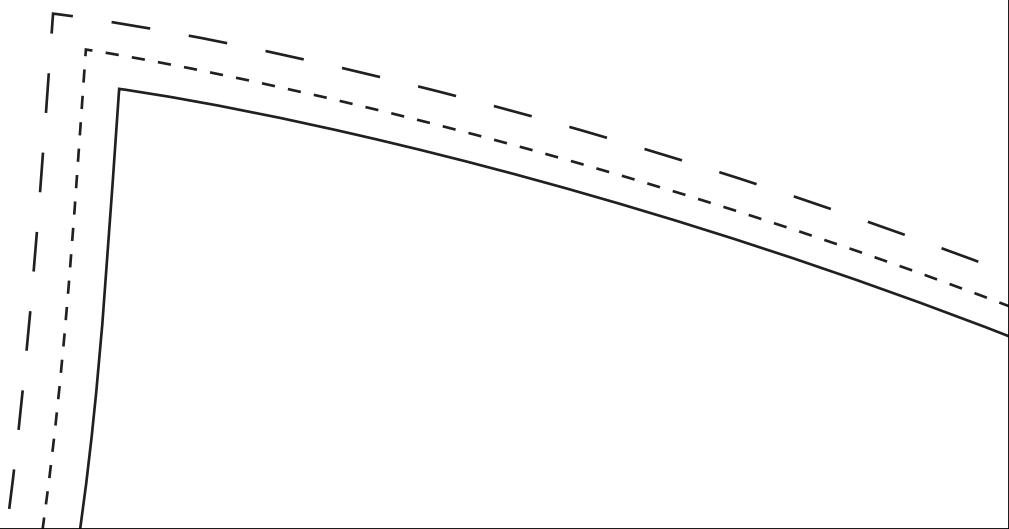

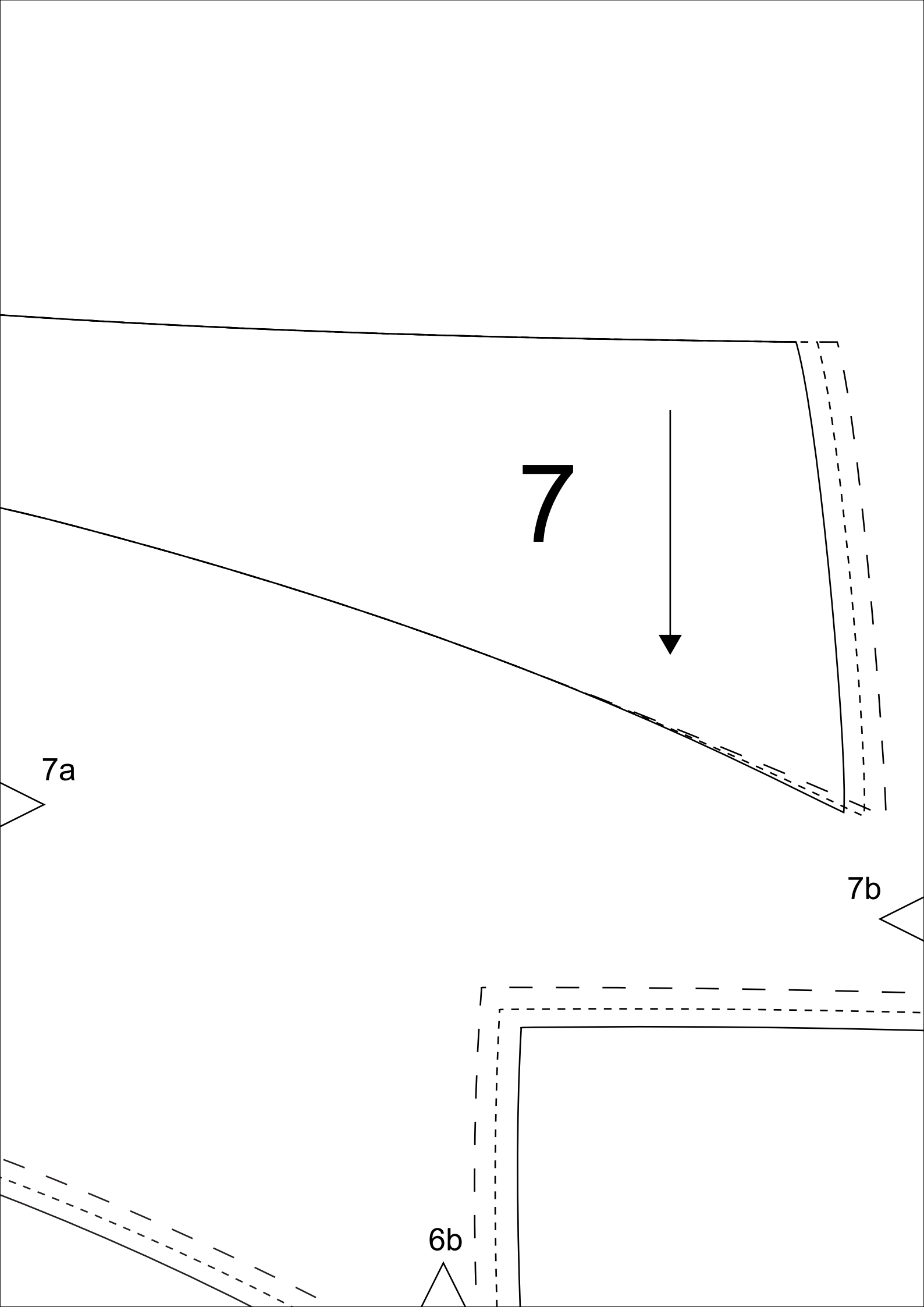

10

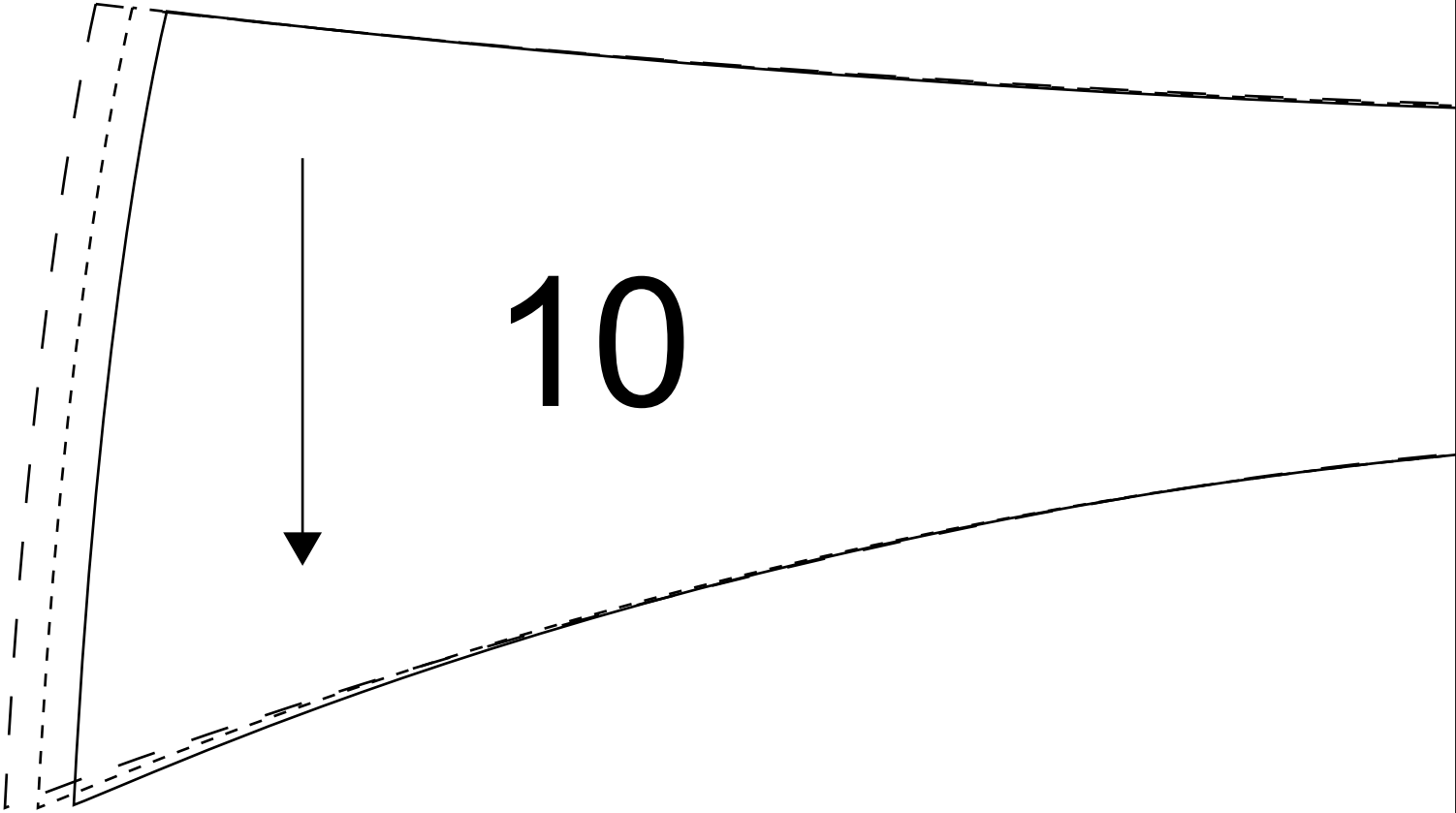

7c



7b

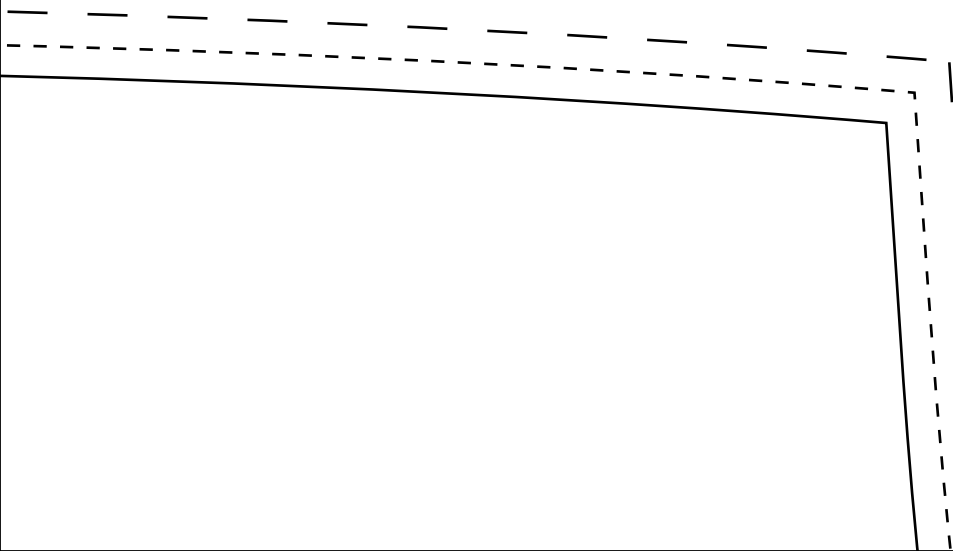

6c



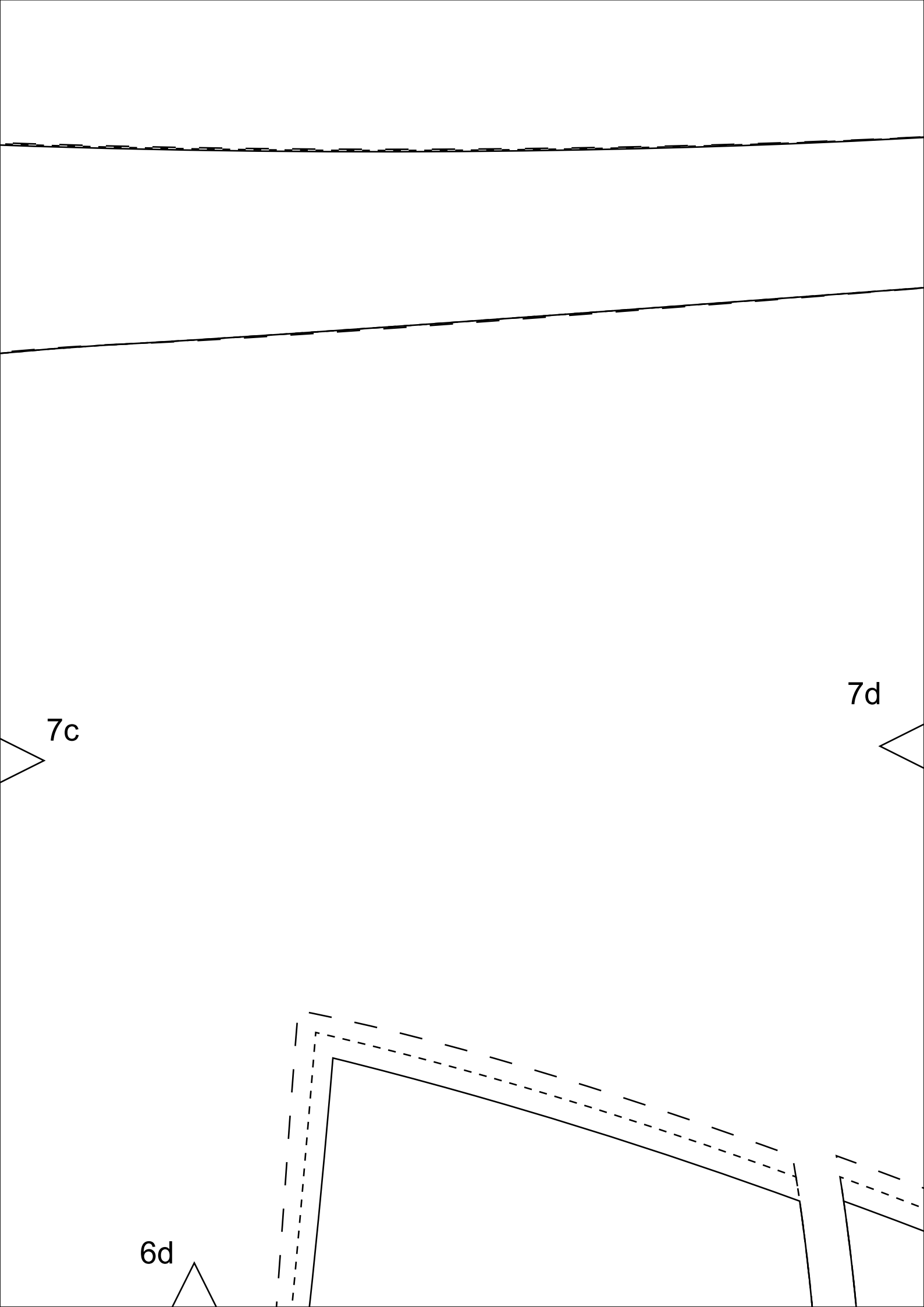

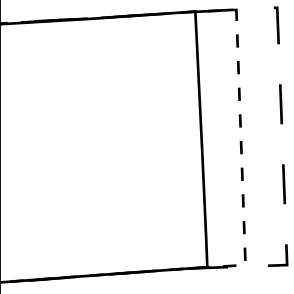

7e

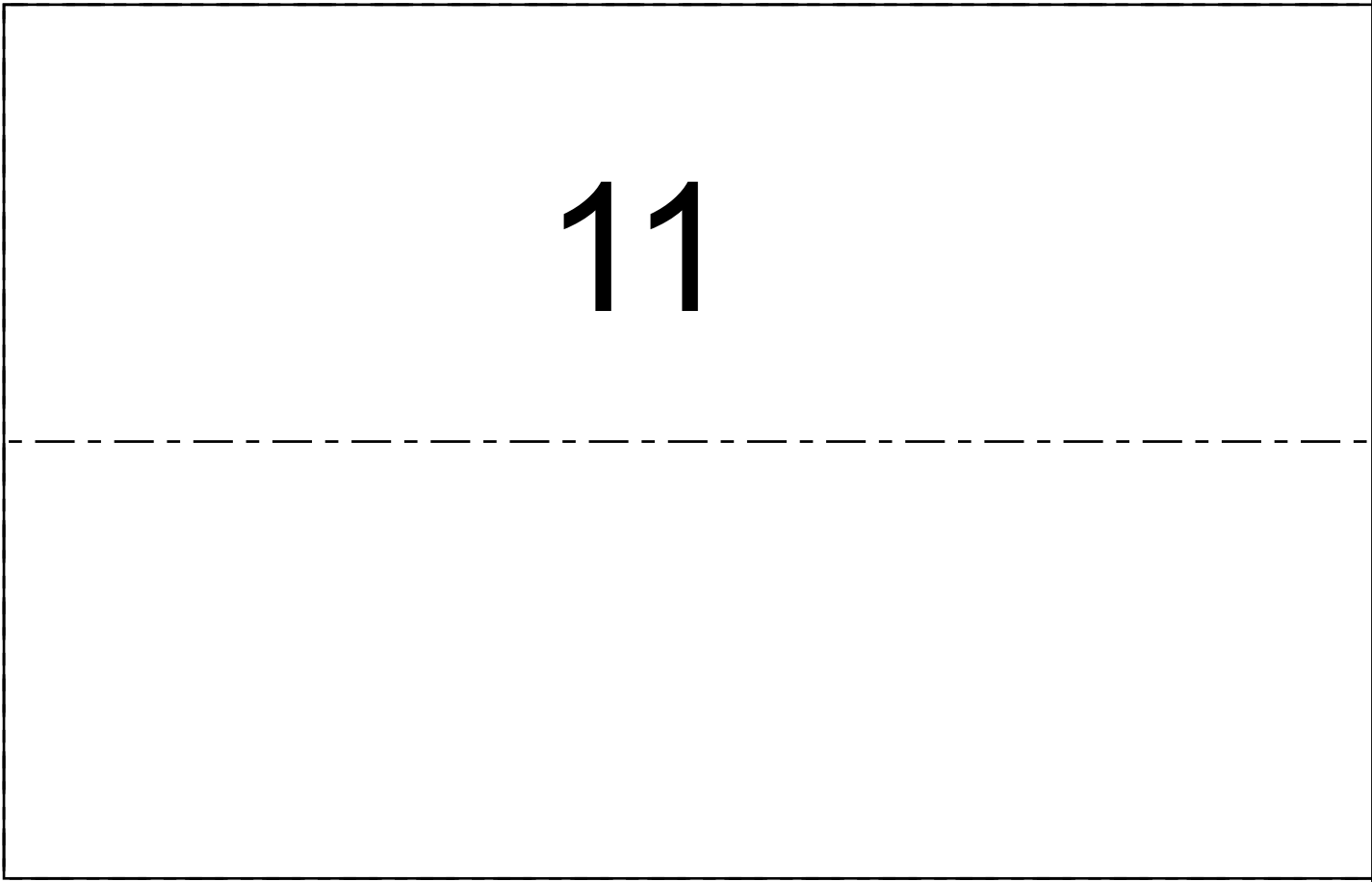

11

7d

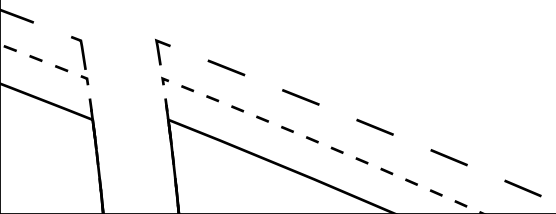

6e

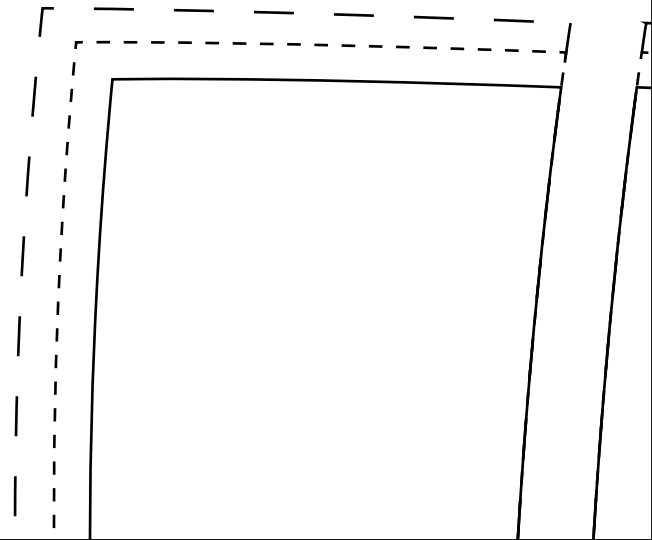

36 —————
38
40 - - - - -

7e

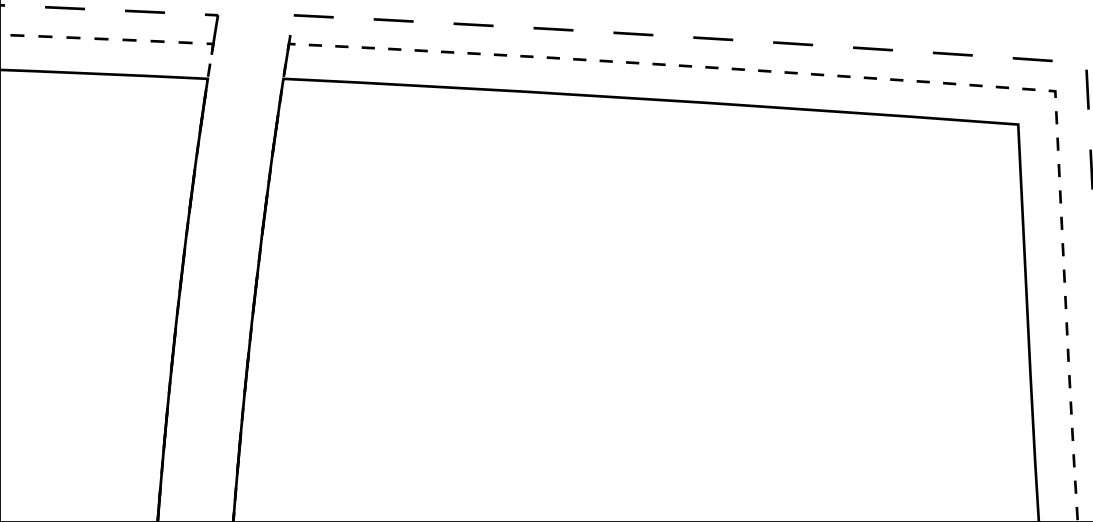
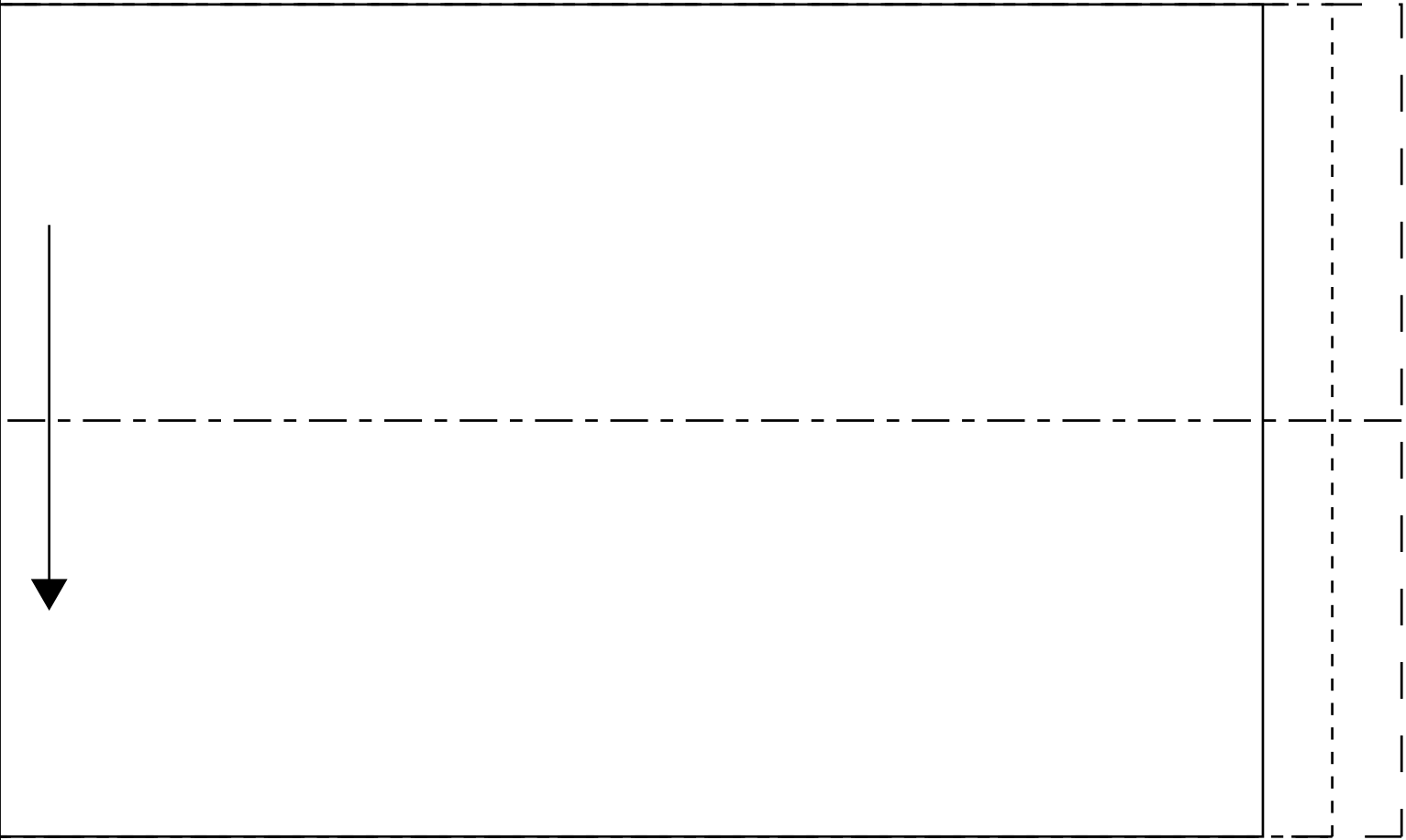

6f



6a

8

5a

4a

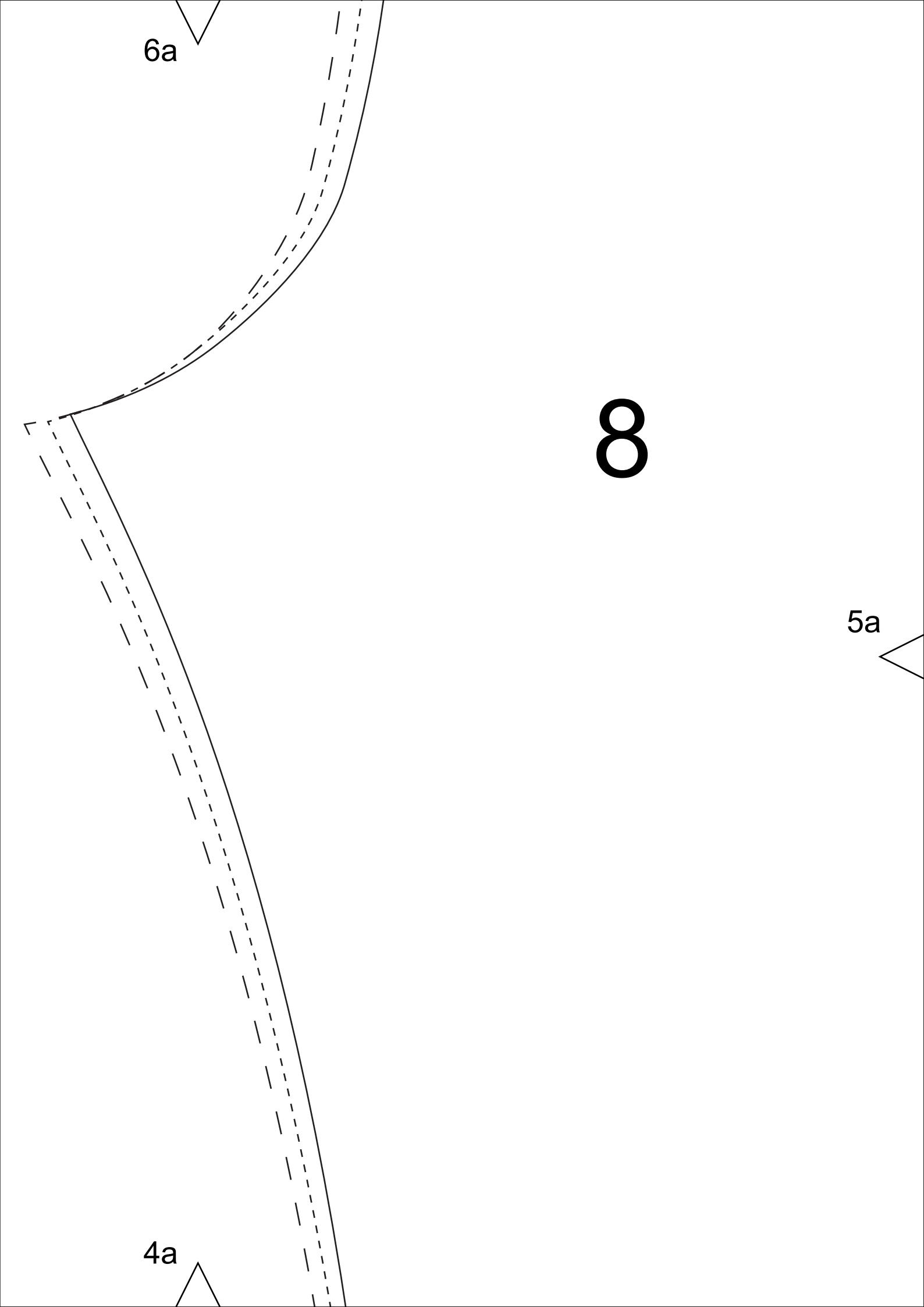

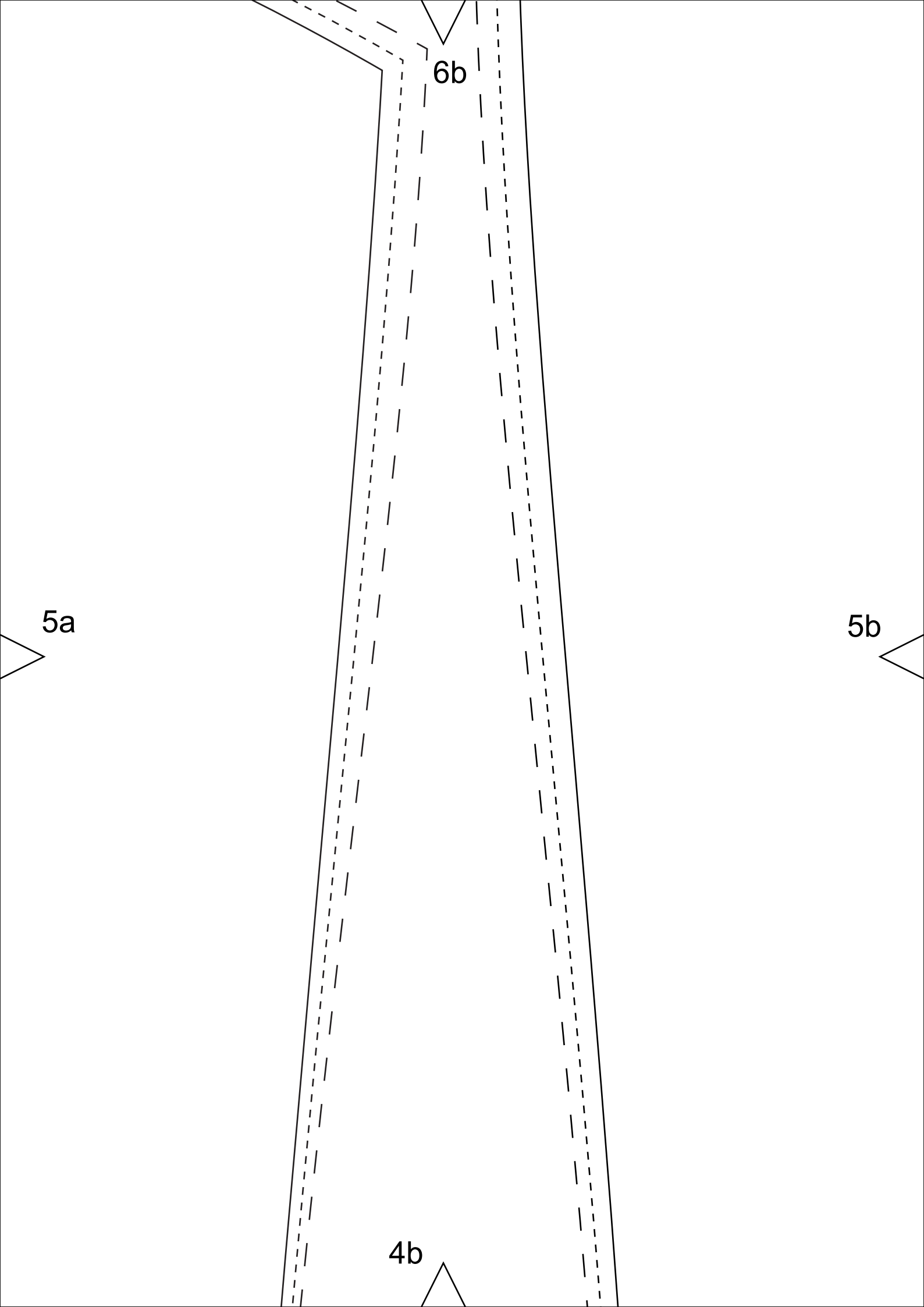

6b

5a

5b

4b

9

5b

6c

5c

4c

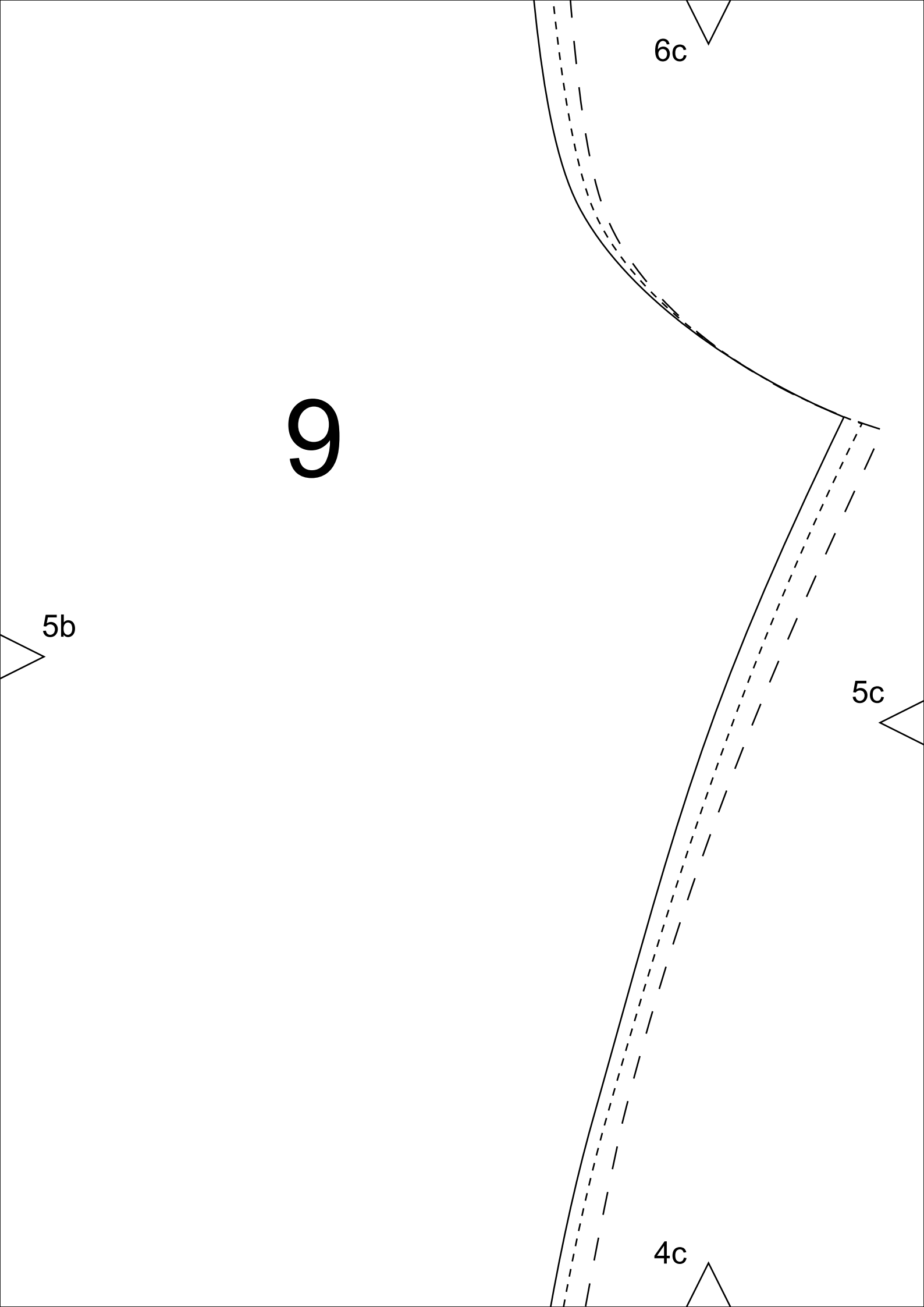

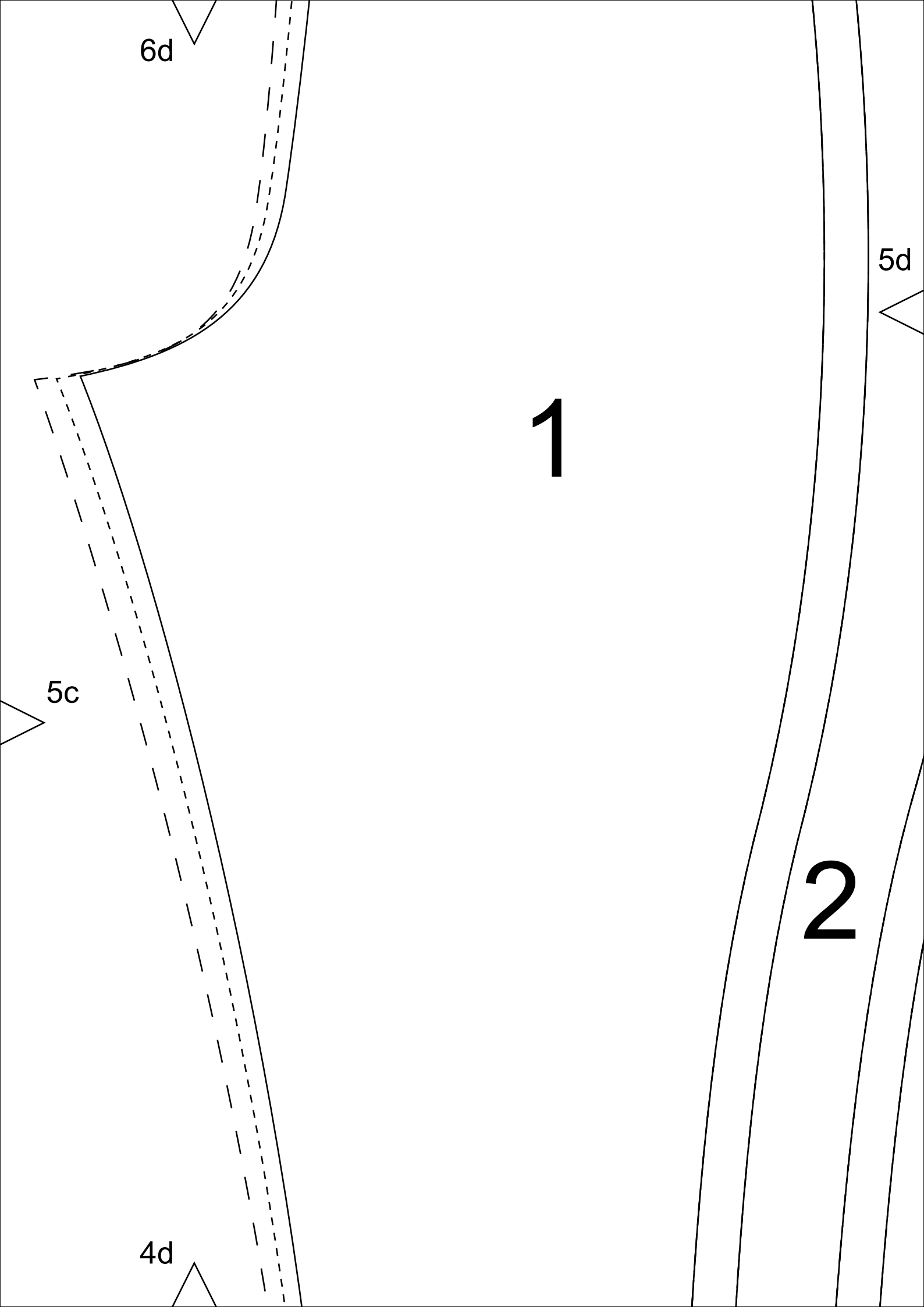

6d

5d

1

5c

2

4d

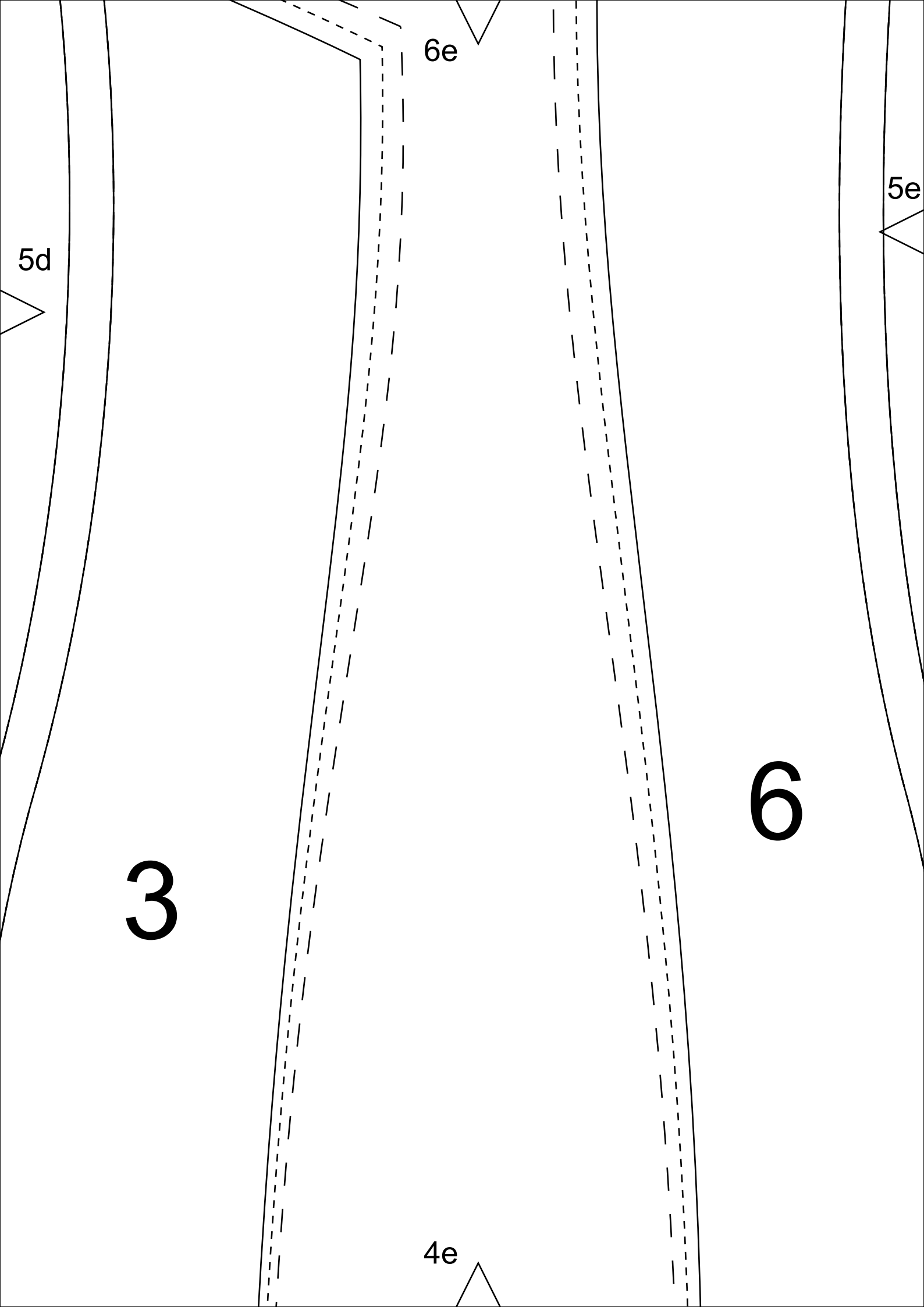

5e

5

4

6f

4f

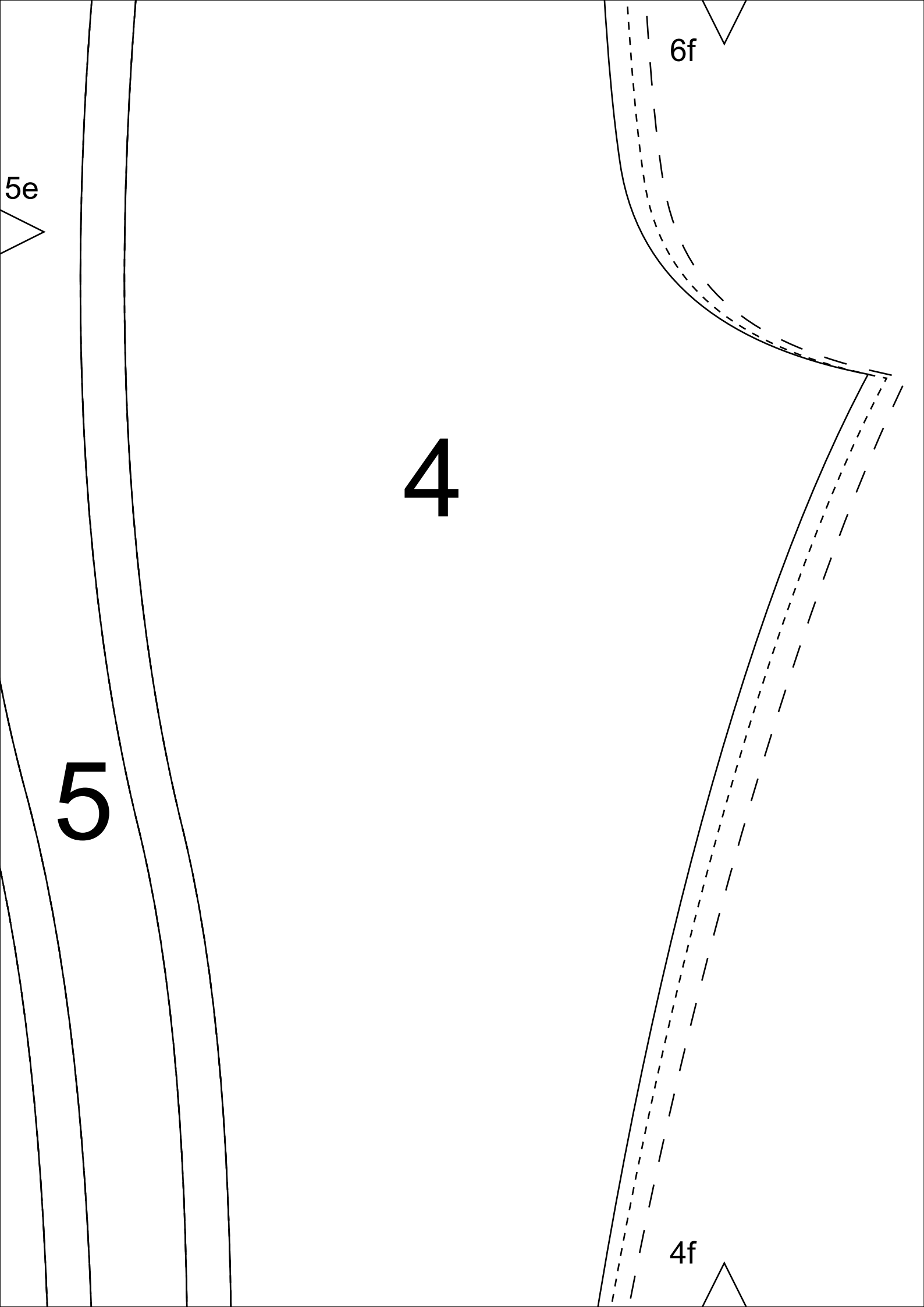

4a

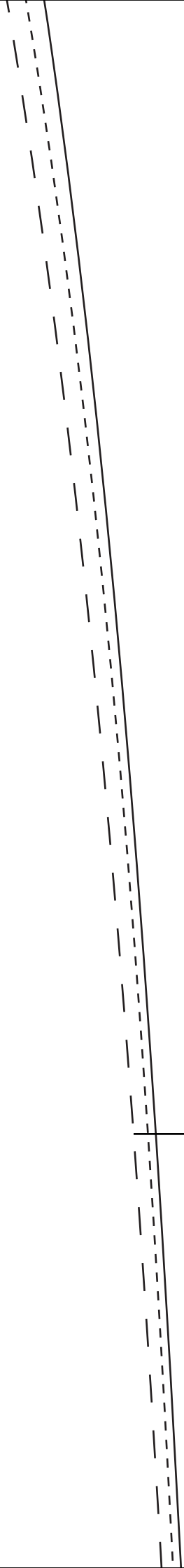

3a



2a



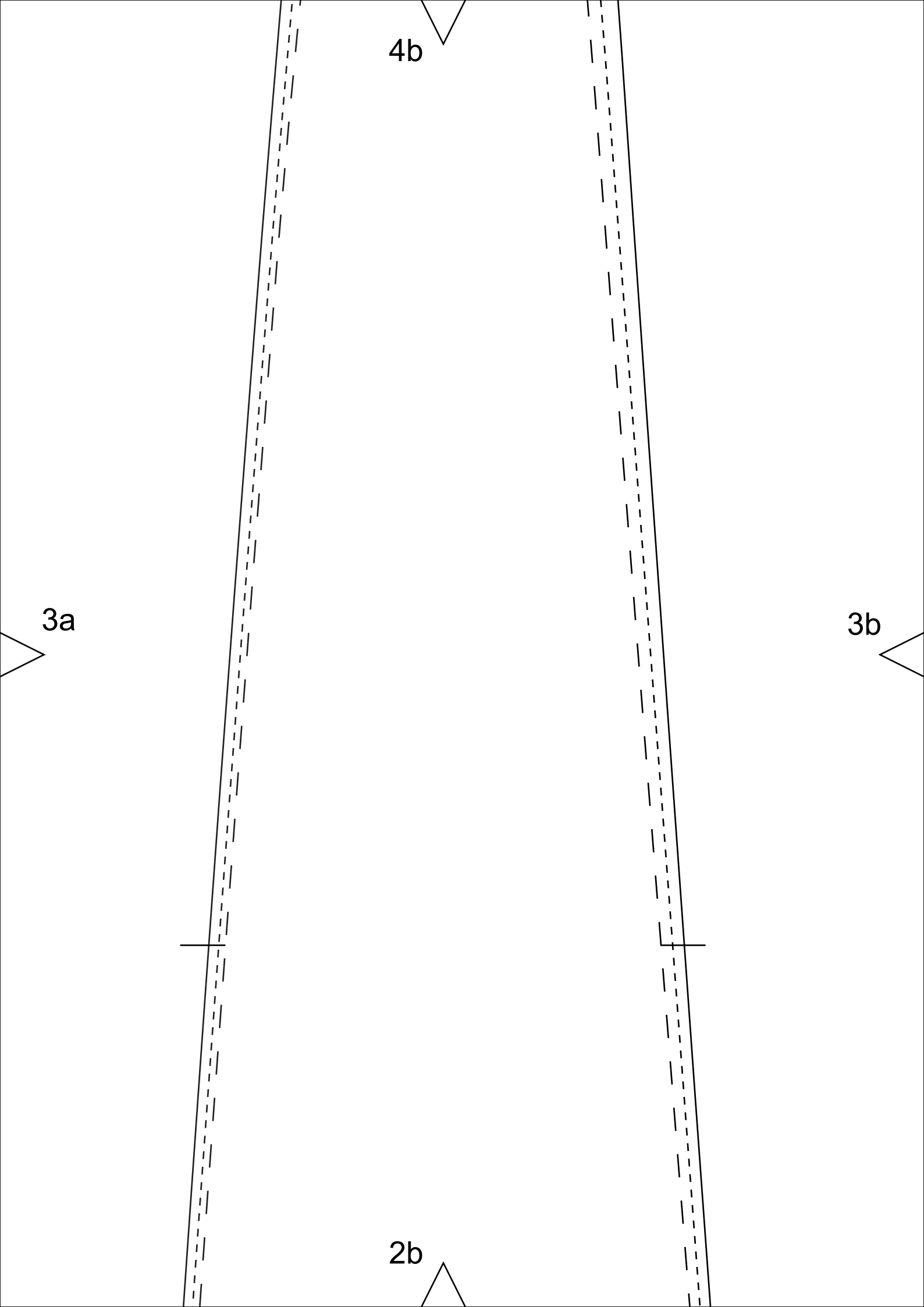

4b

3a

3b

2b

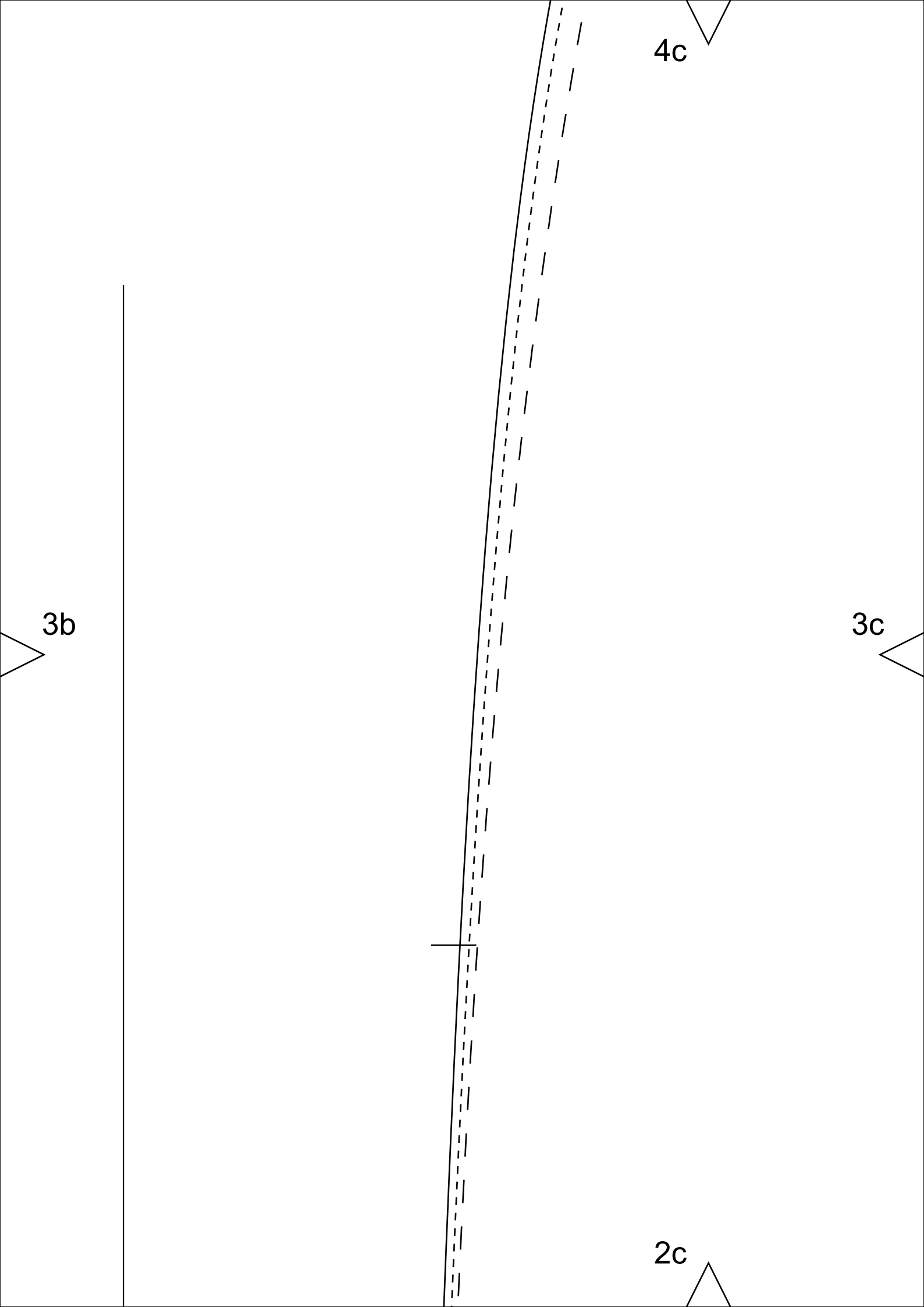

4c

3b

3c

2c

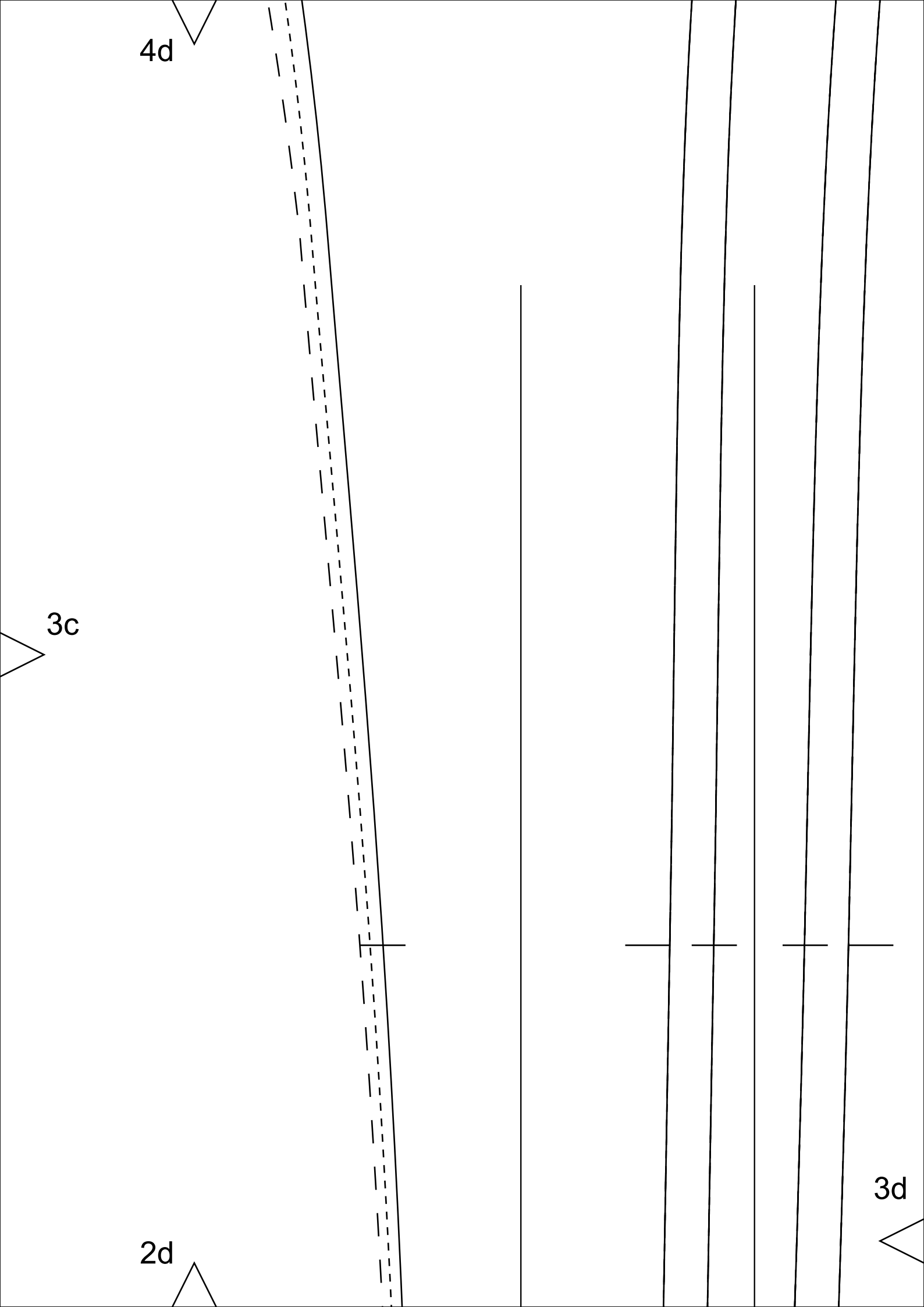

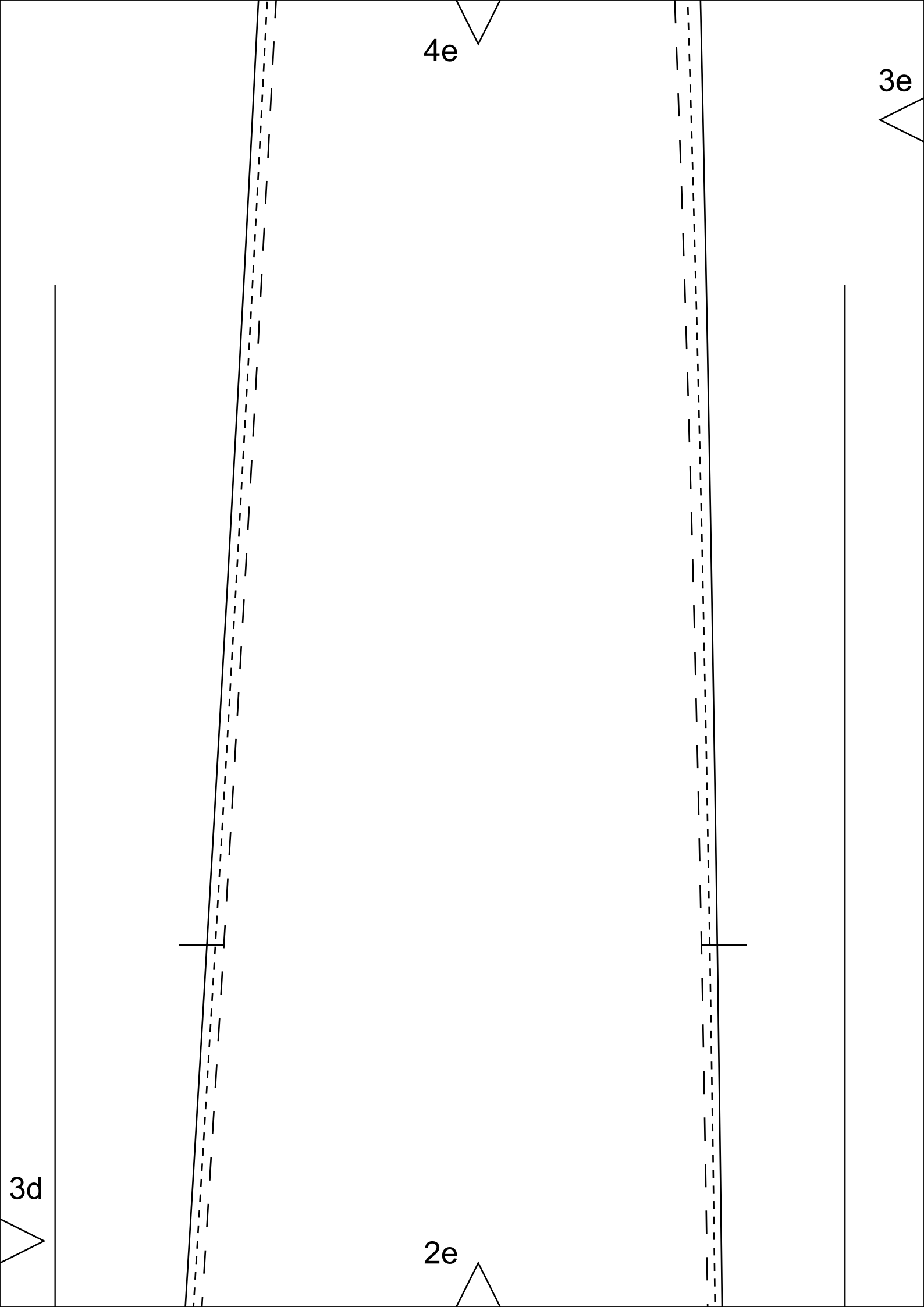

4e

3e

3d

2e

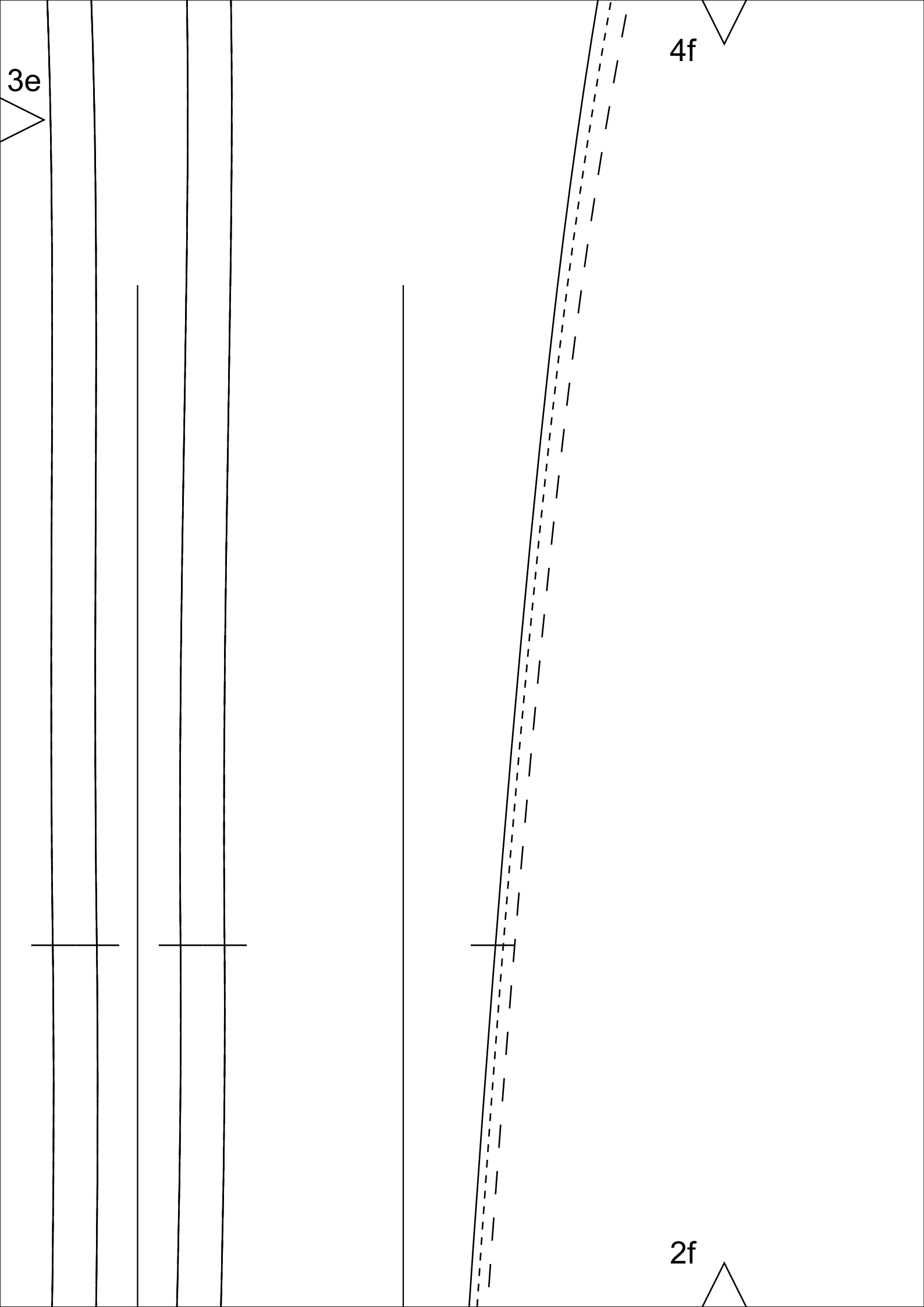

3e

4f

2f

2a



1a

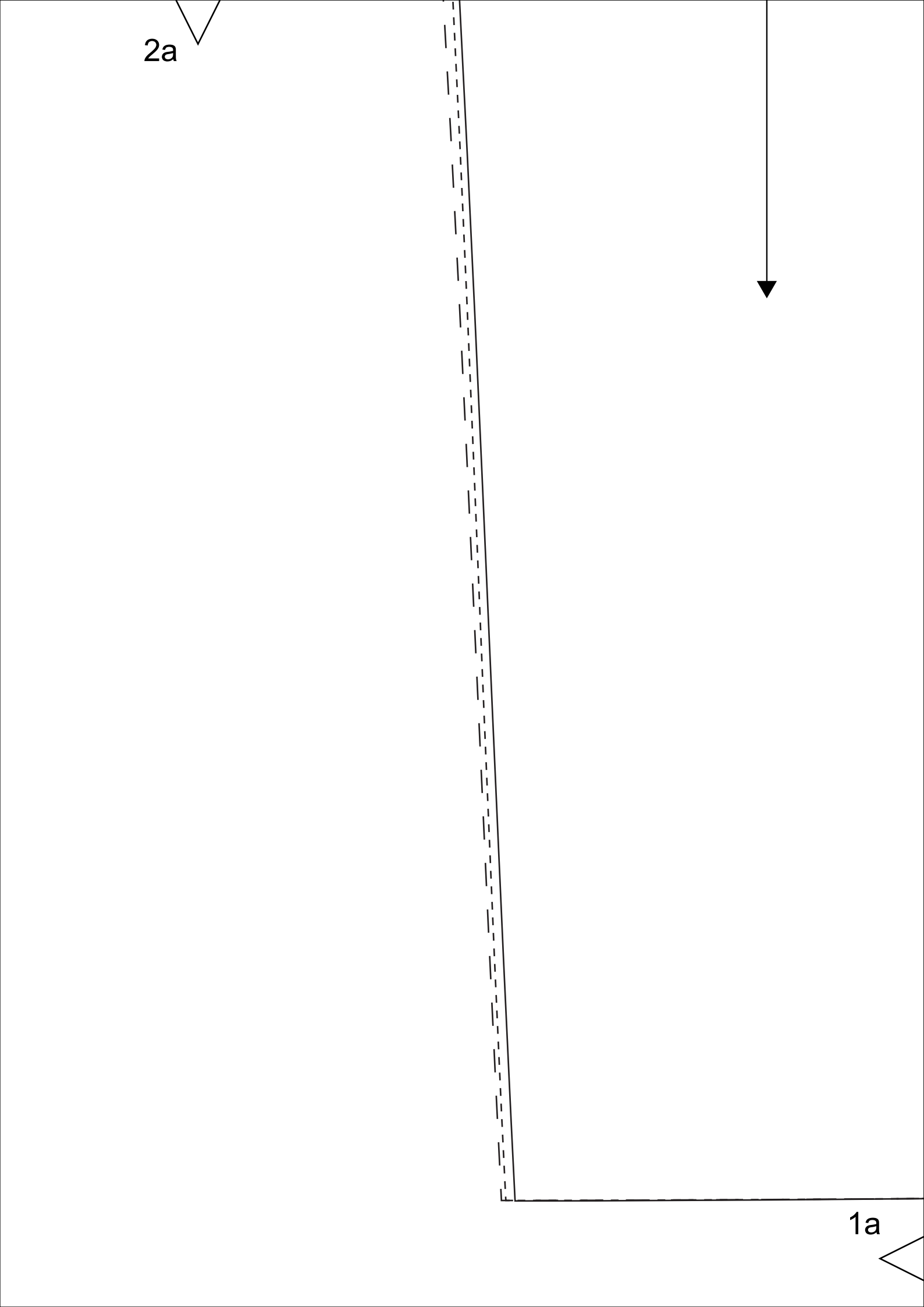

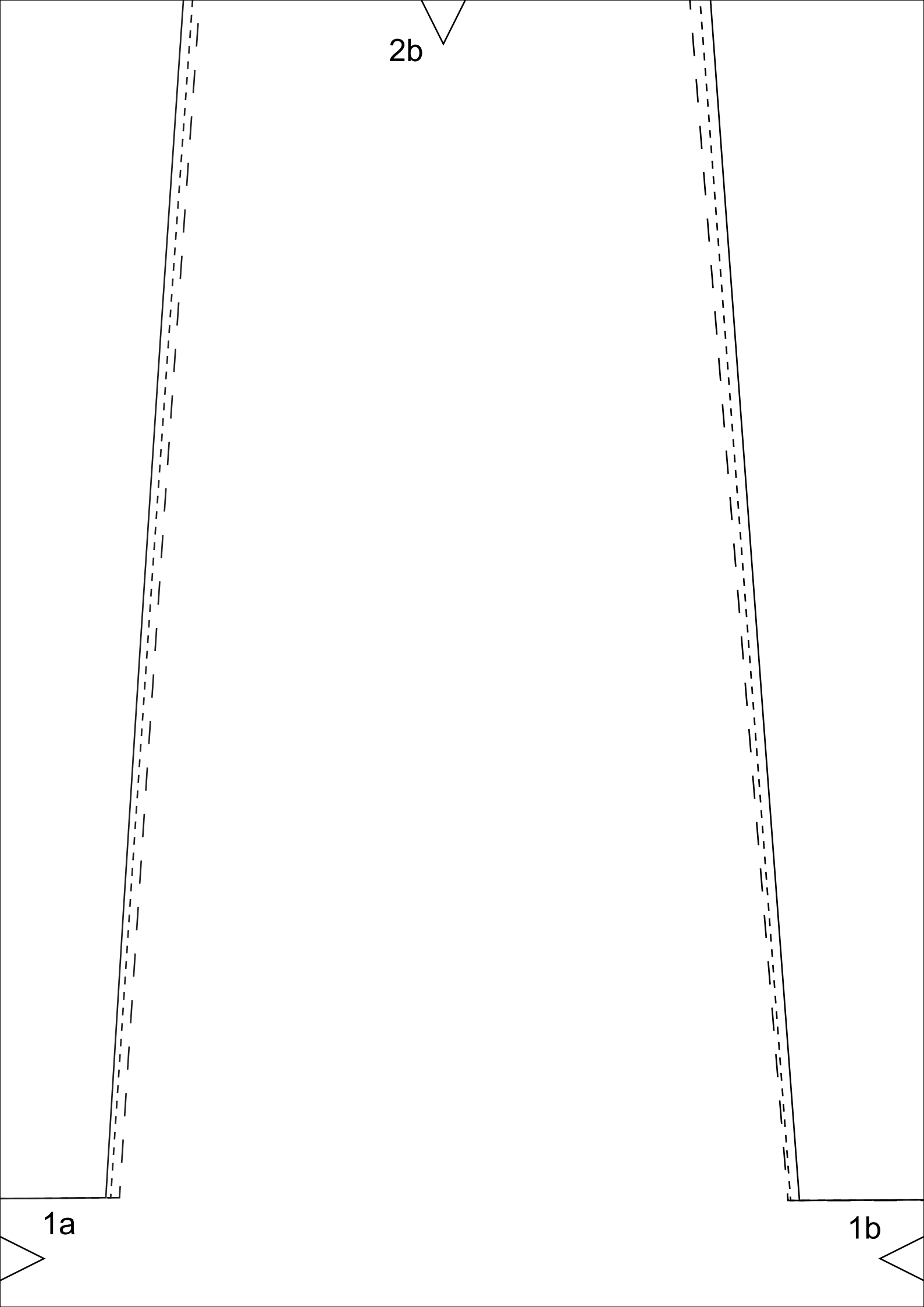

2b

1a

1b

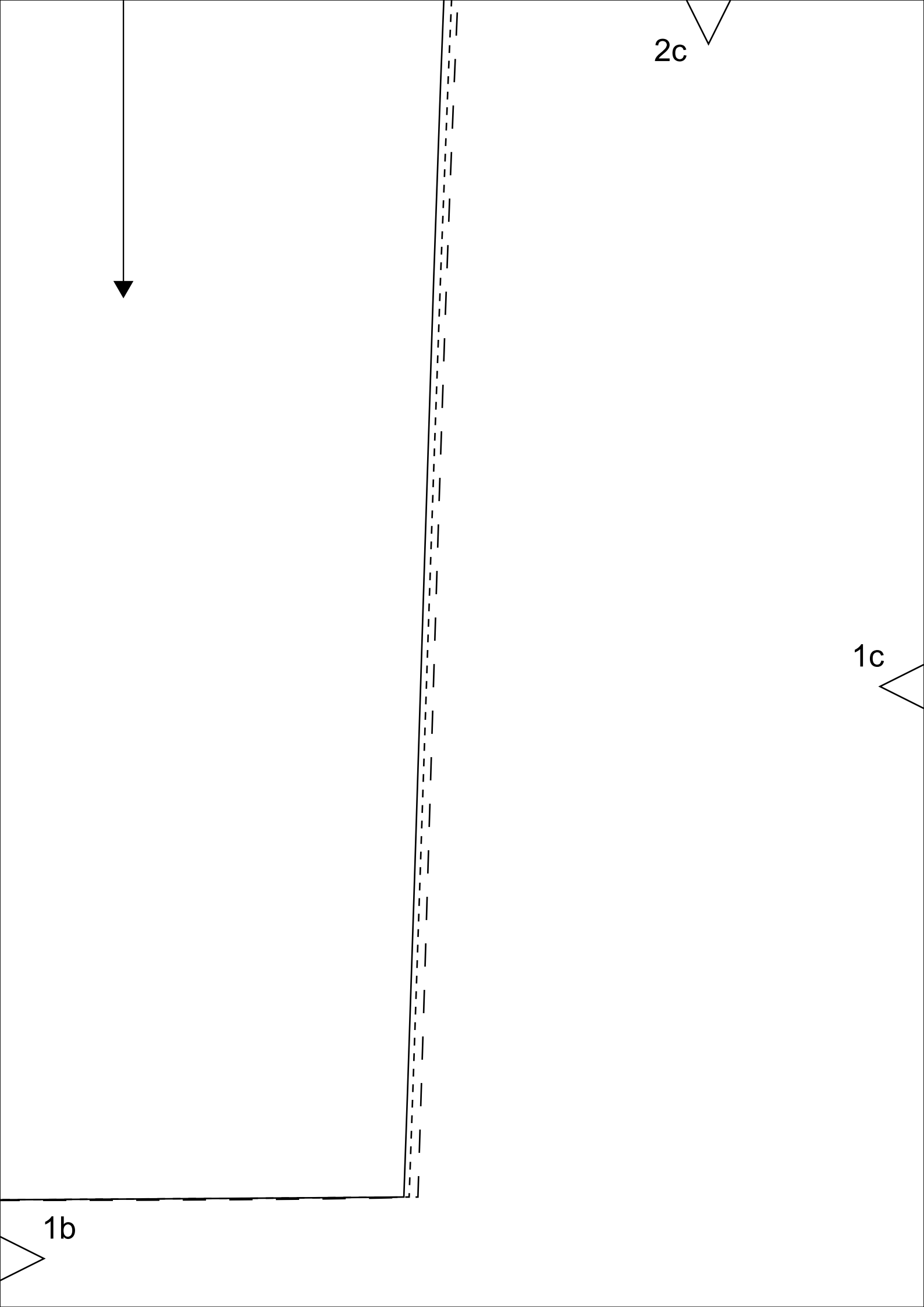

2c

1c

1b

2d

1c

1d

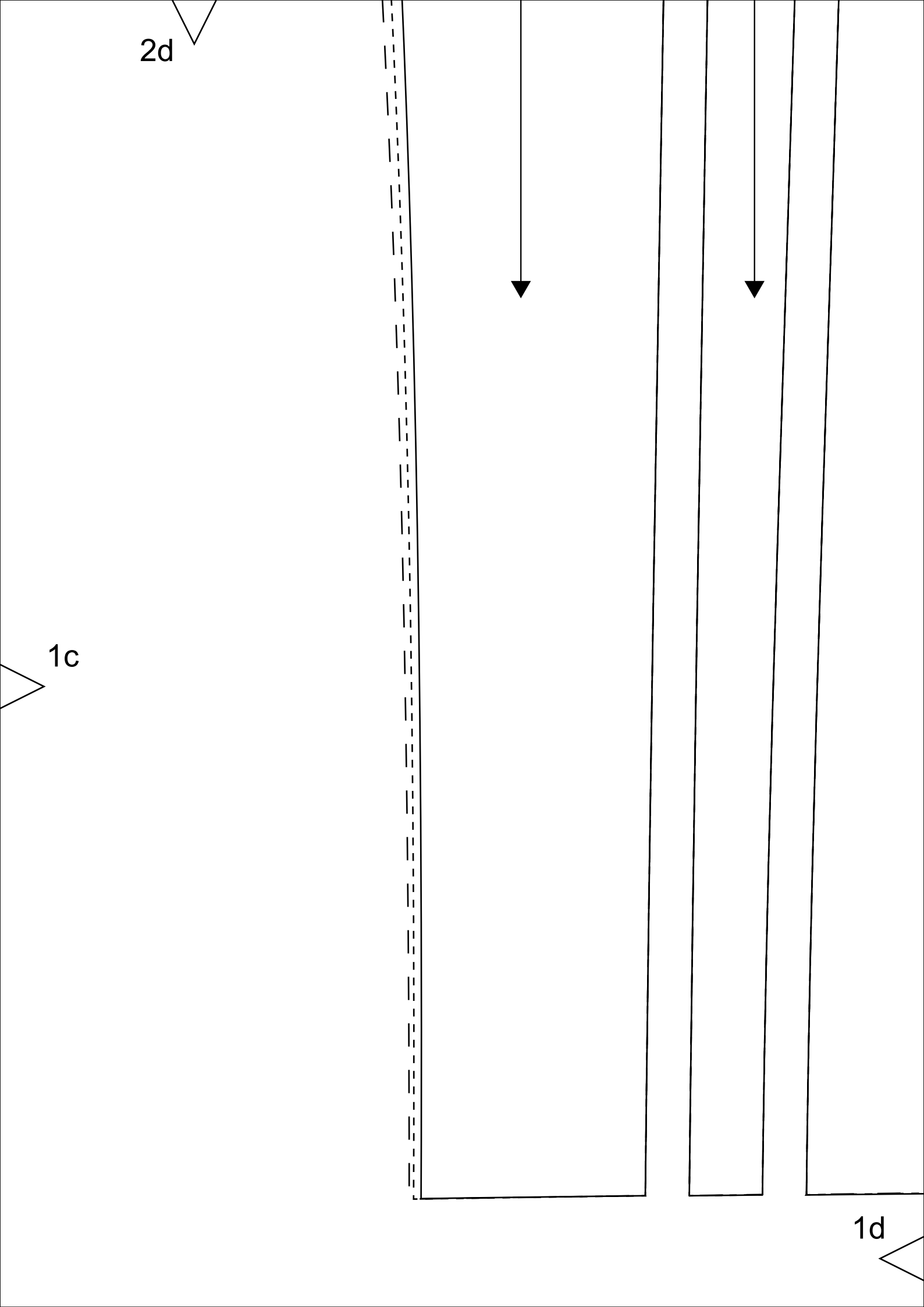

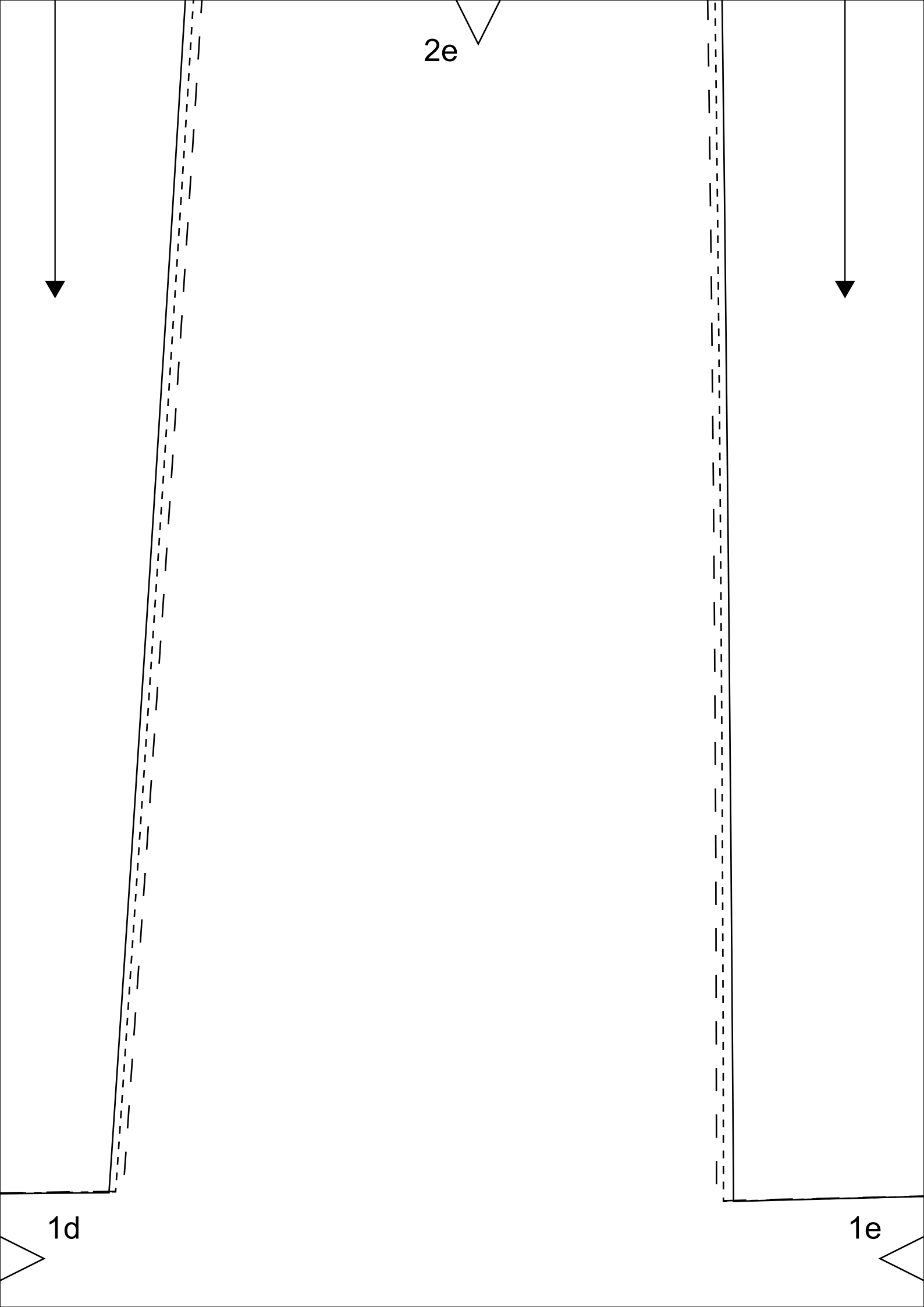

2e

1d

1e

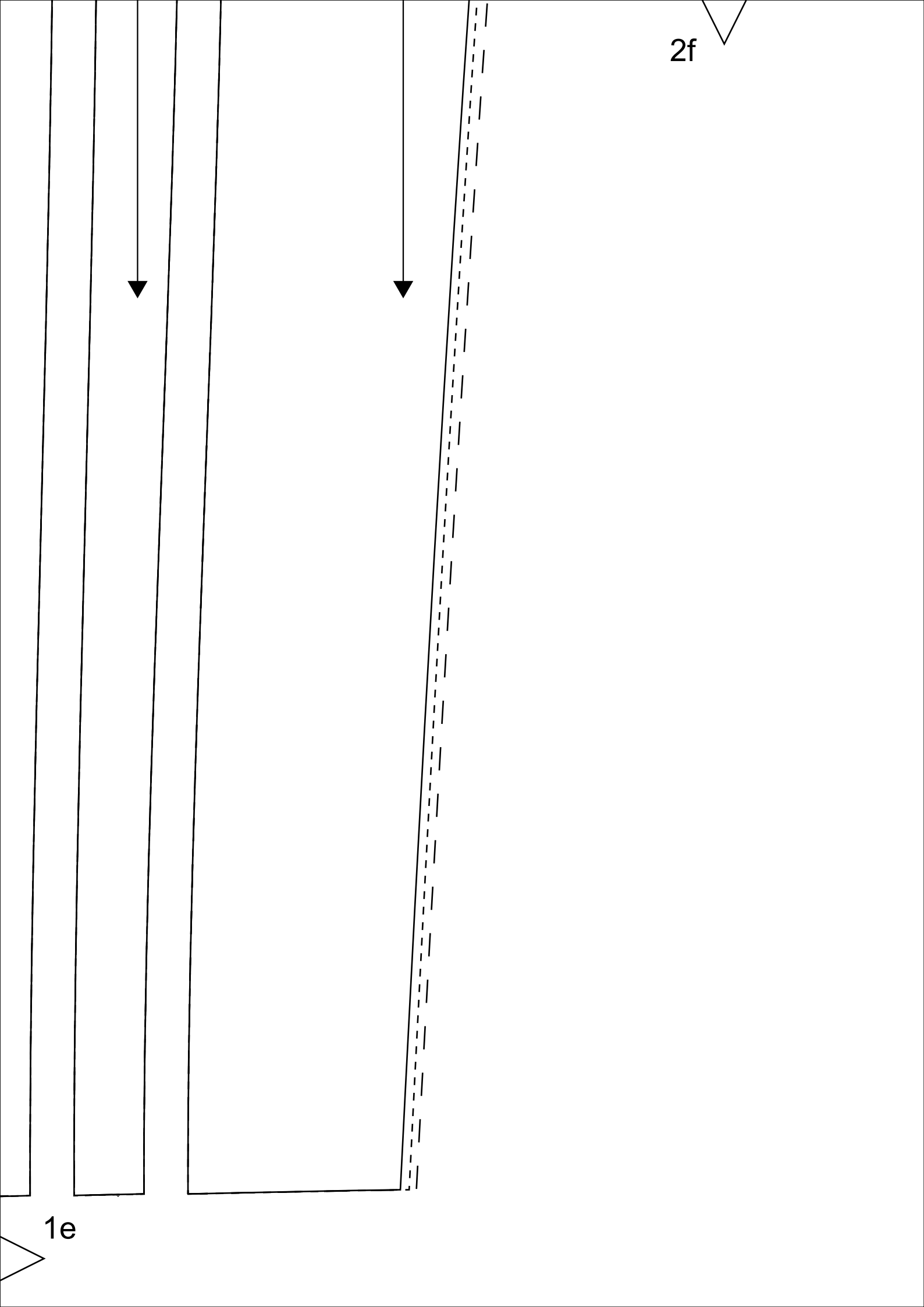

1e

2f